



This is a digital copy of a book that was preserved for generations on library shelves before it was carefully scanned by Google as part of a project to make the world's books discoverable online.

It has survived long enough for the copyright to expire and the book to enter the public domain. A public domain book is one that was never subject to copyright or whose legal copyright term has expired. Whether a book is in the public domain may vary country to country. Public domain books are our gateways to the past, representing a wealth of history, culture and knowledge that's often difficult to discover.

Marks, notations and other marginalia present in the original volume will appear in this file - a reminder of this book's long journey from the publisher to a library and finally to you.

Usage guidelines

Google is proud to partner with libraries to digitize public domain materials and make them widely accessible. Public domain books belong to the public and we are merely their custodians. Nevertheless, this work is expensive, so in order to keep providing this resource, we have taken steps to prevent abuse by commercial parties, including placing technical restrictions on automated querying.

We also ask that you:

- + *Make non-commercial use of the files* We designed Google Book Search for use by individuals, and we request that you use these files for personal, non-commercial purposes.
- + *Refrain from automated querying* Do not send automated queries of any sort to Google's system: If you are conducting research on machine translation, optical character recognition or other areas where access to a large amount of text is helpful, please contact us. We encourage the use of public domain materials for these purposes and may be able to help.
- + *Maintain attribution* The Google "watermark" you see on each file is essential for informing people about this project and helping them find additional materials through Google Book Search. Please do not remove it.
- + *Keep it legal* Whatever your use, remember that you are responsible for ensuring that what you are doing is legal. Do not assume that just because we believe a book is in the public domain for users in the United States, that the work is also in the public domain for users in other countries. Whether a book is still in copyright varies from country to country, and we can't offer guidance on whether any specific use of any specific book is allowed. Please do not assume that a book's appearance in Google Book Search means it can be used in any manner anywhere in the world. Copyright infringement liability can be quite severe.

About Google Book Search

Google's mission is to organize the world's information and to make it universally accessible and useful. Google Book Search helps readers discover the world's books while helping authors and publishers reach new audiences. You can search through the full text of this book on the web at <http://books.google.com/>

**Prize essay on
the
construction
of a simple and
mechanically ...**

Moritz Grossmann

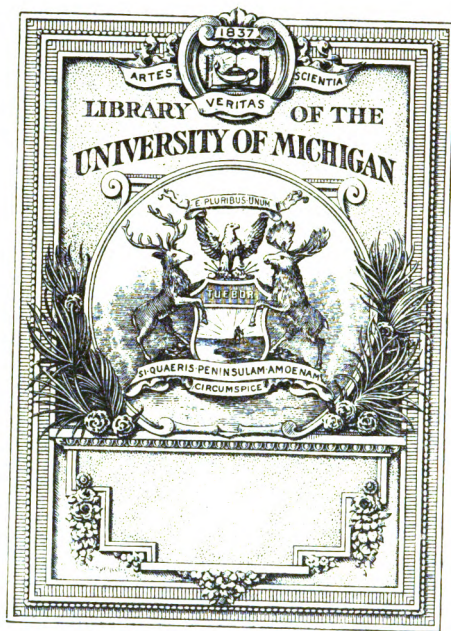

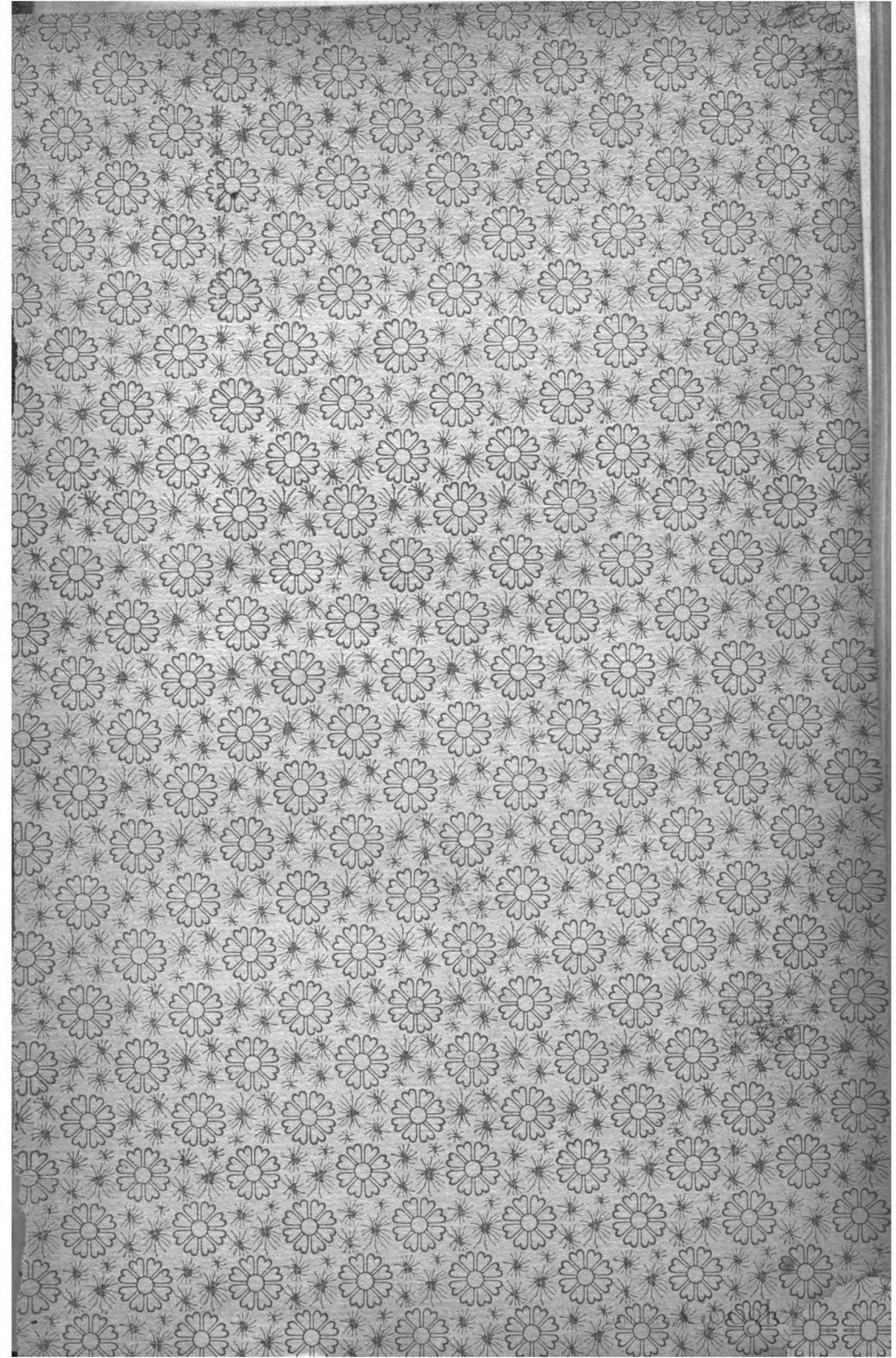

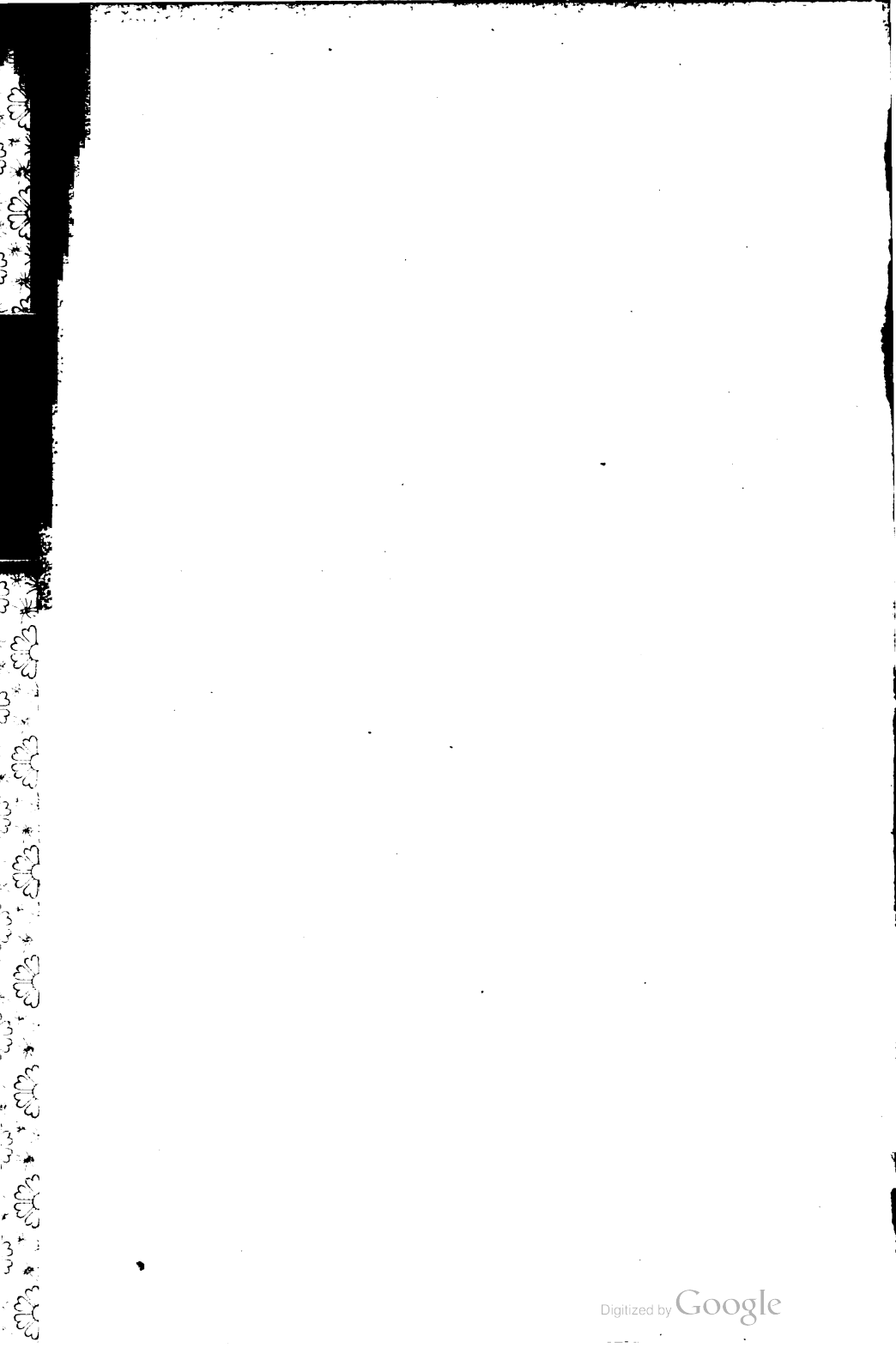

~~4, 6, 7~~

Astron. Obs.,

Astronomical
Observatory

TS

545

, G883

PRIZE ESSAY

ON THE CONSTRUCTION OF A

5-2111

SIMPLE AND MECHANICALLY

PERFECT WATCH

BY MORITZ GROSSMANN

ILLUSTRATED WITH 38 DIAGRAMS

CHICAGO:

GEO. K. HAZLITT & Co., PUBLISHERS.

1891.

**Entered according to the act of Congress,
by G. B. Miller, in the office of the
Librarian of Congress, at Washington.**

CONTENTS.

CHAPTER I.

	PAGE.
The Frame. The different varieties. Full plate, three-quarter plate and skeleton. Advantages and disadvantages of each. Position of Pillars. Material for frames	15

CHAPTER II.

The Barrel and Mainspring. Dimensions of Barrel. Barrel Arbors,	23
---	----

CHAPTER III.

The Click Work. Its Construction. Exposed Clicks and Click Springs. Material for Clicks,	29
--	----

CHAPTER IV.

The Stop Work. The Frictional Stop. The various styles in vogue with their advantages and disadvantages. The Maltese Cross. The substitution of a spring for stop. The Philippe Free Spring,	31
--	----

CHAPTER V.

The Train. Its Dimensions. Uniform Transmission of Power. Shape of Wheel Teeth. Sizes of Trains. Arrangement of Train. Safety Pinions. Shape of Wheel Teeth, in reference to Strength,	39
--	----

CHAPTER VI.

The Motion Work. The adjustment of the Minute Hand to the Canon Pinion. The setting of Hands. The Dial. Dial Fastenings. The Color of Hands. The Seconds Dial,	47
--	----

CHAPTER VII.

The Escapement. A review of the various escapements. Right Angle and Straight Line Levers. Diameter of Escape Wheel. The Fourth Wheel and Escape Pinion. The Balance Cock. Steady Pins. Size of Balance. Compensation Balances,	51
---	----

	PAGE.
CHAPTER VIII.	
The Casing. The various methods with their advantages and disadvantages,	57
CHAPTER IX.	
The Jeweling. Examination of Holes. Advisability of Jeweling a movement Throughout. Plain and Capped Jewels compared. Diamond Endstones. The Setting of Jewels. Screwed Jewels,	61
CHAPTER X.	
The Fusee. Its advantages and disadvantages. The Equalizing Power of the Fusee. Advantages of the Going Barrel. Improved construction of Fusee Movement,	67
CHAPTER XI.	
The Keyless Mechanism. Its advantages. Classification of Keyless Mechanisms. The Setting Hands mechanism and proper arrangement. The Rocking Bar and other constructions compared.	75
CHAPTER XII.	
Keyless Open Faced Watches. Inconveniences in the Construction. An improved method of Construction. Winding. Form of Teeth of Winding Wheels. Material for Winding Parts. The Push Piece,	89

INTRODUCTION.

THE construction of a good watch is undoubtedly one of the most complicated problems in the whole range of practical mechanics. Not only the small dimensions, but also the absolute necessity of confining the whole mechanism to a space of a certain shape, which must not be transgressed nor altered, together with the claims to mechanical perfection and exterior elegance, are difficulties which may not be encountered in the same degree by any other branch of engineering.

The ingenuity and skill of the practical horologists have nevertheless contrived many different constructions of watch movements, and especially in Switzerland, that old center of watch manufacturing, there exists an incredible variety of designs, more or less happily adapted to their purpose. In reviewing so many different expressions of the same fundamental idea, the attentive observer will not fail to arrive at the conclusion that a great part of these different patterns have been invented in order to produce something novel and original, or to suit some taste or fashion. Some of them, indeed, make an impression as though a watch were a fancy article, and not a scientific instrument.

This was certainly one of the chief motives which caused the Board of Trade of Geneva to open a competition for the study of a simple and normal movement. Being impressed with the usefulness of a clear treatment of this matter, and having become practically acquainted with the manufacturing systems of Switzerland, England, France and Germany, I resolved to enter into this competition; and I had the satisfaction to see that my reflections on the subject were favorably judged and approved by the jurors.

I have translated this essay, originally written in French, into English, at the same time revising and correcting it carefully,



and adding some additional remarks, especially referring to English watches. I am well aware that watch manufacturing in the United States is carried on in an altogether different way from what it is anywhere else. The excessive cost of skilled hand labor has led to an extended employment of mechanical appliances, and it is really gratifying to learn what amount of skill and sagacity has been developed in the construction of automatic and self-measuring little machines.

The system of perfect identity of the parts of the movement is certainly very commendable, and affords great facilities in manufacturing large quantities. It has already been adopted in Paris and Geneva, and the possibility of maintaining this identity within certain limits is no longer doubtful. Still it seems to me that this system ought not to be extended to the manufacturing of the escapement, which, in carefully made watches, ought always to be treated as an individual—especially the lever escapement. The horizontal escapement, on the contrary, would admit much better an identic treatment.

Watch manufacturing in Switzerland is organized in a very different way from what it is in the United States. In Switzerland a number of comparatively small establishments get up the movements—that is, the frames, wheels and pinions, barrels and clickwork. The watch manufacturer orders or buys them, and gets the casing, motion work, escapement and finishing done. The leading principles in the construction of the movements are better not inquired into, as they seem to be governed by the taste of the customers rather than by mechanical science. This organization gives rise to great irregularities and inconveniences in manufacturing, which has caused several houses of importance, especially in Geneva, to create a complete manufacture of movements for their own wants in inclosed localities, much in the same way as it is now done in the watch factories of the United States.

The English way of manufacturing presents the same general feature so far as the movements are concerned; but the completion of these latter is much more dispersed all over the country, and at almost every place there are watchmakers



who, besides attending to their repairing business, do more or less in the manufacturing line; so that comparatively few pure manufacturers, in the Swiss style, will be found in that country. This system has the decided advantage of fostering the taste for new work, and of affording facilities to those desiring to carry out any scheme of a new escapement, etc. On the other hand it puts the manufacturer of movements rather out of the reach of his customers' influence and wishes, and this, together with other circumstances, must account for many astonishing imperfections in the getting up of movements. Many English manufacturers are aware of them, but not able to enforce their views to the movement makers. In the last decade one or two of these latter have begun to work on the system of identity, but I have not heard anything as to their success.

The English, Swiss and French manufacturers of movements are exhibiting one common inconvenience, viz.: the want of a generally acknowledged working standard, and of adequate measuring instruments. In France and Switzerland the horological population hold with uncommon tenacity to the antiquated measuring system based upon the "*Pied de roi*" (the King's foot), though neither of these countries has a king. This system, in total inharmony with the political institutions, with the monetary and measuring systems of those countries, and with the daily social practice, is entirely impracticable for calculation and intercomparison, and not very appropriate to the dimensions of watchwork, and ought to be abolished and replaced by the metric system. If I am correctly informed, this latter has been introduced in the factories of the Geneva establishments above mentioned.

The English manufacturers are working upon the unit of the English inch—still more unfit for watchwork than the Paris ligne; but the majority of special parts are classified by their makers in arbitrary sizes without any reliable standard, and without any guarantee that a certain size of one maker is uniform with the equally numbered size of another maker. The disadvantage of such a state of things could not fail to strike the observation of the thinking horologists there; and

in fact the inconveniences arising from it are rendered much more perceptible from the fact that watch manufacturing is spread all over the United Kingdom, while the movements and materials are only made in the Lancashire district. Thus, the London manufacturer has to get his movements—wheels, pinions, hands, etc., etc.—from a distance of at least one hundred and fifty miles, and it is easy to understand that it requires a good deal of practice to do this without frequent mistakes, owing to the want of a generally acknowledged standard of measuring.

This caused the British Horological Institute to issue a circular in 1861, by which information was asked about a good and practical universal measuring system; and it was expressly stated that the suggestions to be made should in no way be bound to the actual English standard of measuring. I forwarded a detailed description of the method and instruments in use here in Glashutte for employing the metric system. This was published two years afterwards, and warmly recommended by the special committee appointed for the gauge and measuring question. No other communication was published afterwards, except an eccentric gauge, which, by its nature, admitted no connection with any standard, and so concluded that no one had sent another suggestion. Nevertheless, the opinion of the committee has found no followers, and English watch work is, up to the present day, measured by inches and their fractions.

In my Treatise on the Detached Lever Escapement I expressed my opinions on the matter in detail, and tried to prove the perfect applicability of the metric system to watch work, and the calculation of its dimensions and proportions.

It is very much to be regretted that the watch factories of the United States had not at once introduced the metric measurement, which affords so great facilities; and it might have been very easily done, because everything had to be created anew, and because these factories form, as it were, each a world for itself.

The Swiss watch manufacturers have complicated their task in a very unnecessary way by creating a great variety of sizes

of movements. Their regular sizes begin at 10 lignes and go up to 21 lignes, thus giving twelve sizes. But a too great readiness to meet the most minute exactions of their customers, has led them so far as to have even sizes by half lignes. The English watches have also about seven regular sizes. This I think too many, and a gradation by 1 ligne (about 2.5 mill.) is finer than required to meet even the most pronounced taste. If five sizes were adopted, differing by 3 mill. from each other, the manufacturing would be very much simplified. The sizes then would be 34, 37, 40, 43 and 46 mill., and would embrace the whole range from 15 to 21 lignes. Watches smaller than 15 lignes, or 34 mill., ought not to be made.

The factories of the United States have not made so much concession to the difference of taste of the public. So far as I know of, they make chiefly two sizes of watches, one for gentlemen and one for ladies. Most likely the equalizing and levelling character of the republican institutions of that country has assisted them in doing so, and much to the advantage and convenience of the trade, I am sure.

To these introductory remarks I will merely add that, for establishing the proportions of the parts of movements, I think it the best way to find their relation to the diameter of the pillar-plate in as simple fractions as it can be done.

According to my opinion, the question: *What caliper is the best for the cheap production of a simple but mechanically perfect and sound watch movement?* can best be answered by studying the designs already employed, as to their relative merits, and by choosing the most commendable of them; or, if the actual methods do not seem convenient, by creating a new one.

CHAPTER I.

THE FRAME.

THIS part must be the beginning, because the way in which it is made influences most essentially the physiognomy of the movement, the arrangement of its organs, and even the shape of the case. A watch, as well as any other machine constituted mainly by rotating parts, requires a frame for sustaining both ends of each moving axis. This frame has to fulfil the same general mechanical requirements as in other machine.

2. On looking over the frames, as they are made in the different manufactories, we may distinguish three different modes of construction:

The full plate movement.

The three-quarter plate movement.

The movement with cocks—or skeleton movement.

We will, in the first place, have to compare these three systems for the purpose of choosing the one offering the greatest advantages for the fabrication, and the best conditions for the solidity and good service of the watch.

3. The movement with cocks is almost exclusively adopted in the Swiss manufacturing, and it must be acknowledged that it is, more than any other one, calculated to exhibit the mechanism of the watch favorably to the eye, and give a rich look to the movement. At the same time it is of a more complicated nature, and it can not be manufactured or finished for the same price and in the same time of a full or three-quarter plate movement. The same observation applies to the taking to pieces and putting together; and it is not unlikely that the workmen employed in the manufacturing, as well as the repairers, would protest against this system if, instead of being sanctified by the practice of a rather long period, it were to be introduced now.

4. The frame, with cocks, of a horizontal watch requires ten to eleven screws for the cocks only, and sixteen steady pins; the frame of a three-quarter plate movement only seven screws and six steady pins. Thus, the adjustment of the three pillars balances itself by the adjustment of three to four screws and nine to ten steady pins; an undeniable advantage in favor of the three-quarter plate movement, when cheap and quick manufacturing is kept in view. Besides, there are four cocks to be made instead of the upper plate, especially the consideration of the shaping and finishing of these numerous parts, which shows an essential economy in favor of the three-quarter plate.

In repairing, the same inconveniences prevail; the number of the separate parts is too great in the movement with cocks, which occasions necessarily a loss of time in the operations of taking to pieces and putting together.

5. The stability of the depths, together with the vertical position of the pinions, is endangered by each bending of a steady pin in the frame with cocks. It is for all these reasons, that some of the best Swiss manufacturers have dispensed with the cock of the third wheel by annexing the hole for this wheel to the center wheel cock, because this depth, being the highest above the level of the pillar plate, might suffer most from the last-mentioned danger. With this course of ideas, it is only surprising that the same reasons have not at once led to a more radical change of system.

6. It may be asserted as a merit of the movement with cocks, that it affords more facility in taking out certain parts; *i. e.*, the barrel, in case of a broken spring, or a piece of the click-work, or stop-work in disorder. But even this little advantage does not really exist, because, for taking out the barrel, if the hole in the plate for this latter is not too wide, or if the steady pins of the barrel cock are rather long, the center wheel must be taken off first, and for doing this; if the spaces are limited, it is often required to lift also the cock of the third wheel. Then there are four screws to be unscrewed, instead of the three of the three-quarter plate. Thus there remains the more slightly exposition of the train as the only advantage of the movement with cocks.

7. The three-quarter plate movement is very rarely made in Switzerland; but so much the more in England, where, for about twenty years, it has obtained a pronounced preference in place of the old full-plate design. It secures the relative position and vertical standing of the moving axes better than the Swiss system, and requires a less number of pieces, and less time and trouble in repairing, still leaving sufficient facility in taking out the parts of the escapement.

8. The arrangement of the train in these two kinds of frames is, however, exactly the same; so that any three-quarter plate movement might be transformed into one with cocks by merely taking off the pillars and upper plate, and substituting them by cocks for each moving axis.

9. The full-plate movement, on the contrary, admits and even requires a quite different arrangement of the train. It is the most ancient of all frames in watch-work, and has been always in great favor in England. This kind of frame has also been generally adopted by watch factories in the United States.

10. It affords the possibility of making the balance of greater diameter than in any of the other frames; but this is an argument of no great importance, because it has long since been ascertained that an excessively large balance, approaching more to the effect of a fly, is not commendable for a good time-keeper. Most likely it was the reduction of the size of balances which caused the English makers to adopt the three-quarter plate movement.

11. The full-plate frame allows of a much easier and more spacious arrangement of the train, and especially in fusee movements the wheels and pinions can be made larger than in a three-quarter plate frame, which is certainly an advantage. But on the other side, for having a main-spring of the same breadth, the full-plate movement requires a considerably greater height of frame and case. This was tolerable at the period when the taste required a case with strongly convex backs, but the fashion of our days insists upon having the backs flat, or nearly so, and this caused the necessity of abandoning the full-plate system, lest the cases should have too disproportionate a height.

12. The full-plate movement is undeniably the most simple; it can be executed with two cocks only (those of the balance), and with an economy which no other system affords to the same degree.

13. The taking to pieces and putting together of a full-plate watch has inconveniences which can only be found supportable by a long practice with this kind of movement. The pottance which carries the lower balance pivot must necessarily overlap the extremity of the fork, or the rim of the escape wheel in case of a horizontal watch, and the workman who takes down the upper plate without the necessary precaution will invariably break the lower pivot of the pallet-staff, or of the escape pinion in the horizontal watch. This happens very often to repairers who take English watches to pieces without attentively considering their arrangement. In fact, to avoid an accident of that kind, the movement must be put together and taken to pieces on the upper plate, which is a very inconvenient method, especially in fusee movements, where the tension of the main-spring must be adjusted anew after each taking down. It is true that all these objections might be easily eliminated by dispensing with the pottance, and setting the lower balance hole in the pillar plate. But an arrangement of this kind would not offer the same certitude of position and end shake of the balance staff.

14. The examining of the escapement, also, in a full-plate movement cannot be made with the same ease as in a movement otherwise arranged. Likewise it is impossible to make alterations on the escapement, or to clean it, or give it fresh oil, without taking the whole movement to pieces.

15. Having thus balanced the merits and inconveniences of these three systems of movements, it will not be difficult to draw the conclusion, *that for the watches of our period the full-plate movement is not admissible; and that from the two other arrangements remaining, the three-quarter movement is preferable for its greater solidity and economy in the execution.*

16. A little saving in the practical execution might be attained by omitting the two lower bridges. The

plate then would only be turned out a trifle on the dial side, just to make up for any unevenness of the dial. The place for the barrel and motion work, and even for the lever escapement, can easily be provided by circular sinks made on the lathe.

In the same way a little advantage in the execution of a three-quarter plate frame would result from omitting the pillar, and making the upper plate of sufficient thickness to screw it directly to the lower plate, securing it in position by three good steady pins. For flat watches this method is to be recommended, as it gives additional solidity. The room for the moving parts must be hollowed out on the lathe. Watches in thin gold cases, thus made with two solid plates, would appear more weighty than they would with plates of common thickness. The setting of the jewels is not so convenient as when it is done in the bridges, but with properly arranged tools there is no difficulty in setting them directly into the plate.

17. The pillars ought not to be placed close to the periphery of the upper plate. On the contrary, they will better meet their purpose if put a little more inside, because the plates cannot be so easily deflected in screwing down when the shoulder of the pillar is not quite correct and square. The two pillars near the barrel ought to be so placed that a straight line from the one to the other comes as near as possible to the barrel center. The barrel is the reservoir of the moving force, and, therefore, the frame must be so arranged that it possesses the greatest strength at this part.

18. There is no absolute mechanical necessity for giving a certain thickness to the plates of the frame, but the pillar plate ought to be sufficiently thick to afford a safe hold for good strong screws, and to contain the pallet and escape wheel so as to be a trifle below the surface of the plate. The upper plate ought to contain the center wheel in its countersink flush with the inner surface of the plate; and, besides, a solid bearing for the upper pivot of the center pinion should be left.

According to these necessities, it will be a good proportion to make the pillar plate of a three-quarter plate or skeleton

movement 0.06 of its diameter. The upper plate ought to be about 0.035 of the same diameter. These proportions, of course, apply only to watches of a mean height (say 0.16, or about one-sixth of their diameter); a flat watch, having a weaker main-spring, and consequently less strain on the frame, and less pressure on the center pinion, can bear a reduction of these thicknesses.

19. The material of which the frame is to be made is also worthy of consideration. A certain degree of elasticity and hardness are required for the purpose; besides it ought to offer the least frictional resistance to the movement of the pivots, and oppose the greatest durability to the wear resulting from this motion.

20. For this last reason steel is out of question here. Besides, it could not possibly be protected against rusting, and magnetism might endanger the rate of such a watch in a most serious way. Still, I will remark here, that I had an opportunity of observing for many years a good watch, constructed by a German maker before jewel holes were at convenient reach. He had, for obtaining greater durability, screwed steel bushings into the plates for all the pivots, the escapement included, and these steel holes, well hardened and polished, showed almost no wear at all after more than fifty years performance, and kept the oil remarkably well.

21. Brass answers fully all the requirements of a good watch frame, if by sufficient rolling or hammering it is brought to its greatest hardness and density. Hammering is preferable to rolling, if possible, because this latter process stretches the metal—an effect which is not sought for, and which, at the same time, does anything but improve the quality of the material. Small rollers stretch the material more than large ones. I have made a rather tedious series of experiments in order to find out the best way of obtaining the greatest possible density of brass. For this purpose I constructed a small tilt hammer of about 3 lbs. weight, striking five to six blows in a second, and adjustable to perfect parallelism with its anvil. I found that a strip of brass worked with it did not show the slightest increase in breadth and

length—a proof that the considerable amount of mechanical work bestowed upon it had gone exclusively in the useful direction. By comparing I found a strip of 1 millim. thickness, reduced to 0.9 millim. by this vertical hammering, to equal in elasticity a strip of 3.0 millim. reduced by rolling to the same thickness. This latter was stretched out to $2\frac{1}{2}$ times its former length.

Thus it is clearly to be seen that the work done by the rollers is mostly expended in stretching the metal—and that only a small fraction of it serves the real purpose. This stretching is a source of great injury to the solidity of the metal, not only because it produces fissures at the edges of the strips, but also because it multiplies the size of the smallest defects (flaws or holes) in the metal to double and triple their size, while vertical compression will rather mend them. I could not continue my experiments on a larger scale, because this little tilt hammer was the maximum of what a man can drive with a foot-wheel, and I had no machine power at my disposal. But the result obtained led me to the conclusion that the method generally used for attaining the necessary density and elasticity of brass is altogether wrong. I should prefer to stamp out the rough plates and other parts with punch and die from the common hard rolled sheet brass to be bought in any shop, allowing about 10 per cent. extra thickness for the reduction by the vertical blow. Then each part ought to be put on a flat anvil and submitted to the powerful blow of a falling block, adjusted exactly parallel to the face of the anvil. Such a method would offer another advantage, of making the two faces of the blank piece quite smooth and level, so that it would not require so much to be taken away as when prepared in the usual way.

22. The plates of English watches are, as a rule, very soft, owing to a bad practice of the gilders in exposing them to a high degree of heat; I do not know for what reason, for it requires no proof that a very good gilding can be effected without heating at all. Their upper plates, too, are generally too thin, and especially with the screwed jewels, the screw heads of which are sunk into the plate; they give very much

trouble to the repairer, owing to the very small amount of stock left for the screw threads in that soft metal.

23. For some years there has been an increasing demand for the so-called *nickel movements*. These are made of *German silver*, and that incorrect denomination is derived from nickel, one of the chief constituents of this alloy. There can be no doubt that German silver is a first rate material for watch-work, from its elasticity and hardness, and I refer the reader for further particulars about this matter to the comparative experiments published in my "Essay on the Detached Lever Escapement," Chapter XIV. A nicely polished and grained German silver movement is certainly a handsome looking article, and its surface resists remarkably well all atmospheric influences, while brass needs to be protected by gilding. Still, when touched in a careless way with perspiring hands, it gets very ugly black stains, and in this particular it is inferior to gilt brass.

In all other points, German silver offers no advantage over brass; and it must be said that it is very injurious to the eyes of those who have constantly to work at finishing those bright polished movements. Brass, at any rate, if well prepared, is so nearly equal in physical qualities to German silver, that the demand for this latter as a material for watch movements may be considered a mere matter of taste.

CHAPTER II.

THE BARREL AND MAIN-SPRING.

AN attentive consideration of the way in which this element of the watch is executed by the modern horological manufacturers will result in the conviction that the care which is due to an object of such importance has not been bestowed upon it. This fact is the more surprising, as a great number of cheap lever watches are produced in our day, with escapements so badly made that they can only be brought to a tolerable vibration by an excess of motive power.

25. In arranging the barrel of a watch, the manufacturer ought to be thoroughly penetrated with the principle that the height and diameter granted for a watch should determine the breadth and thickness of the main-spring. It is of the utmost importance to make the barrel as high and wide as the dimensions of the watch will allow of. For this purpose

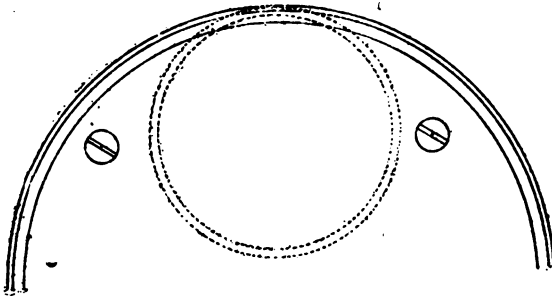

FIG. 1A.

it will prove a good proportion to multiply the outer diameter of the pillar plate by the fraction 0.47 . This will be the diameter of a barrel wheel as large as the size of the watch

will admit (Fig. 1A). It is even possible to go a little beyond this limit, by placing the toothed part of the barrel a little lower than it is commonly done, in order to lodge this largest part of the barrel in the hollow space of the middle rim of the case, where there is always space enough, especially in hunting cases, if the case springs are properly placed (Fig. 1B). In this case, the diameter of the plate may be multiplied by 0.485, for attaining the diameter of the barrel.

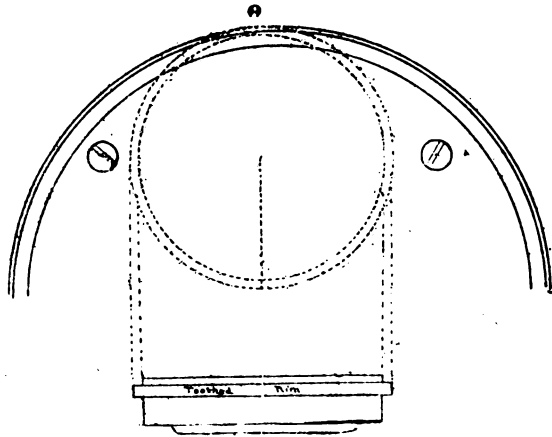

FIG. 1B.

26. The height of the barrel in a three-quarter plate movement ought to be the sum of the height of the pillars and the thickness of the pillar plate, after subtracting only a sufficient space for the free movement between the top and bottom of the barrel and frame plates, and the necessary thickness of the bearing for the lower end of the barrel arbor.

27. It will be easily understood that a watch, the escape-ment and depths of which are imperfect, and made in a careless way, will require a powerful main-spring, while in a carefully made watch, the judicious utilizing of space in the barrel will allow of employing a long and thin main-spring, which, by its suppleness, is less liable to accident, and, by the number of turns it makes in the barrel, affords the advantageous resource of selecting the middle turns of the

development of the spring for the daily march of the movement, and thus to obtain a greater uniformity of motive power.

28. It will also be found advisable to reduce the breadth of the toothed rim of the barrel as nearly as possible to the amount required for the length of the teeth. There are many watches, the barrels of which, already too small in diameter, have also the toothed rim of an excessive breadth, so that much of the space due to the spring is entirely lost. It is quite obvious that a barrel of that kind causes a double loss of power. Not only must the spring be thinner and weaker than it might otherwise be, but also the inner radius of the barrel, which is the lever of power, is shortened; while the radius of the toothed part, which is the lever of resistance, is the same. The same consideration indicates also, that the sides of the barrel ought only to have the thickness required for fastening a solid hook.

29. If all the proportions of the barrel are as they ought to be, a spring of the thickness of $\frac{1}{8}$ of the inner diameter of the barrel will be quite sufficient to produce a lively vibration in a watch with escapement and depths a little carefully made. Such a spring, if the centre of the arbor is one-third of the inner diameter of the barrel, has a development of more than six turns, of which the middle ones may be selected for the daily march of the watch.

30. The way in which to construct the barrel shows a vast difference between the various manufacturing countries. I do not hesitate a single moment to disapprove the system in general use in the Swiss watches. In the greatest part of them the lower end of the arbor has no bearing and support at all, and the barrel is maintained in its place by the ratchet, which

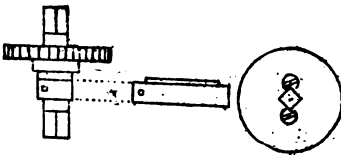

FIG. 2.

is made out of the solid of the arbor. This system shows clearly that the preference which it enjoys is merely due to a blind routine. It offers neither economy of time in the manufacturing and in the repairing, nor a better distribution

of room for flat watches; besides, it is inferior in the point of solidity and durability. In all watches, in those of careful make as well as in those of lower class work, the barrel arbor ought to be supported at both ends by solid bearings; in the former for the sake of greater solidity, and in the latter, also, for that of cheaper manufacturing.

31. There are two modes of executing these free standing barrel arbors. One of them has the ratchet forming part of the arbor itself (Fig. 2), sunk from the upper side into the barrel bridge, and is held in its place by a cap with three or four screws. These screws, having hardly more than three or four threads in the substance of the bridge, are the only means of securing the stability of the receptacle of the moving power in the watch. Every repairer will know, from

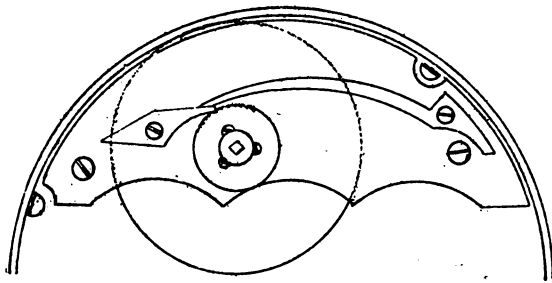

FIG. 3.

oft-repeated experience, that this adjustment is an inexhaustible source of trouble, and that the inner face of the cap or the bottom of the sink are subject to rapid wear by the daily winding, if it has been neglected to oil the frictional surfaces. The consequence of this wear is an excess of shake of the ratchet and of the whole barrel. Any defect of this kind is a very serious one, because the barrel and centre-wheel, the two largest moving parts of the train, have, by necessity, their surfaces very close to each other.

32. With the other mode of execution, the ratchet is screwed with three screws on to the shoulder formed at the part of the arbor just above the barrel (Fig. 3).

This system is still worse from the point of durability. There are only two small annular surfaces which constitute the hold of the barrel. The shoulder of the arbor, as well as the edge of the ratchet, wear away gradually the upper and lower side of the bridge, and the screws slacken their hold by the numerous little jerks of the click when winding the watch. Besides, the ratchet is subject to defects in hardening, and by the three holes and sinks for the screws rather close to the edge. In both these cases the core of the barrel arbor is a separate piece, screwed on the arbor, or adjusted on it and held in its place by a pin through both parts. The finger of the stop-work is secured to the end of the arbor by a pin through this latter.

33. The most advantageous way, both for the manufacturing and repairing, as well as for the durability and good service, is to make the barrel arbor with two pivots, supported each by a bearing. An arbor of this kind is very easy to execute. The ratchet must be fitted on the square of the arbor, which is easier to achieve than the adjustment of the core of the Swiss arbors. There is no necessity of perforating the lower end of the arbor in order to secure the stop-finger in its place, which is attained by the lower bridge of the barrel.

A barrel of this nature is much easier to take to pieces and to put together than a Swiss one. It requires merely taking off the cover of the barrel, and all is done; while with the other one the pin of the stop-finger must be taken off, and after opening the barrel, the pin joining the core to the arbor must be drawn out or the core screwed off, before the parts can be cleaned, or a new spring put in, and afterwards all these arrangements have to be got together again.

34. In a frame, the pillar plate of which was hollowed only 0.2 or 0.3 mill. at the dial side, this space would suffice for containing a thin steel bridge for maintaining the lower pivot of the arbor. The same space would be necessitated for receiving in a solid way the pin for the stop-finger, if we do not wish to create that unfortunate state of many flat watches, in which it is hardly possible to draw out and put in

that pin without splitting the end of the arbor. Thus it will be seen that there is not even an economy of space to be obtained by this system.

CHAPTER III.

THE CLICK WORK.

THE click is a necessary adjunct of the barrel and main-spring, its purpose being to prevent the retrograde motion of the arbor when the winding action ceases. This function being rather out of connection with all the other parts of the movement, it cannot be a matter of surprise to see the click-work executed in a great variety of ways, all attaining the same purpose with more or less ease in the execution, and with different degrees of elegance in appearance.

36. If simplicity and easy execution are required—especially if the click-work is to be sunk into the upper plate—it seems that the round adjustments deserve the preference. The most simple click-work of that kind would consist in the ratchet and click-spring; the latter of circular form, and surrounding the ratchet with only the necessary interval for free movement—both parts to be adjusted in a sink in the upper plate (Fig. 4). The click ought to move on a stud left in the sink, or between two pivots. The whole arrangement would be covered and held in its place by a cap screwed on the plate, and perhaps sunk into it a trifle, just in order to centre it easier. A small hole through the cap, at a proper place, would be useful for lifting the click out of

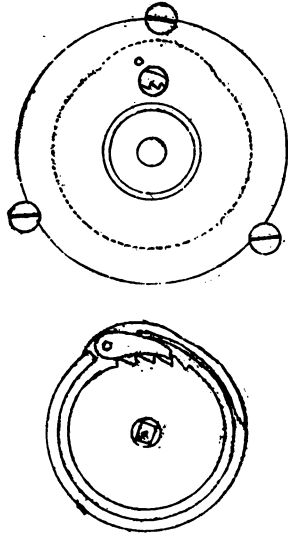

FIG. 4.

action when it is required to let the spring down. It would hardly be possible to have a click-work more simple and cheap of execution, and still quite reliable, than this one.

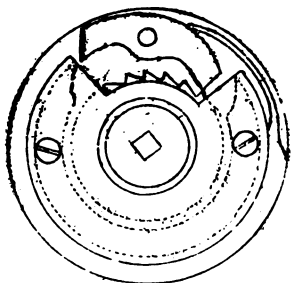

FIG. 5.

37. For watches, in the execution of which a greater degree of elegance is wished for, the click and click-spring may be exposed by leaving a small annular space round the sink that contains the ratchet, on which space the cap is screwed. The spring is lodged into a circular sink outside this space, so that it is only covered a very little by the cap, in order to be secured to its place (Fig. 5). The thinner acting part of the spring may easily be formed in an eccentric chuck on the lathe.

38. It would be a simplification of the click-work to form the click at the acting end of the spring, but the click and

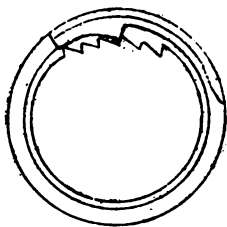

FIG. 6.

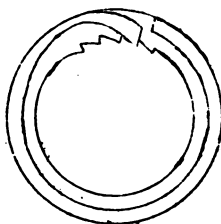

FIG. 7.

spring are much exposed to breakage, and in such a case the replacing of the piece would be a greater trouble (Figs. 6 and 7).

39. The material of which the click-work ought to be made is hardened and well tempered steel, at least for the ratchet and click. The spring might as well be made of another metal of sufficient elasticity, but steel is generally preferred, for the more lively appearance which its polished surface gives to the movement.

CHAPTER IV.

THE STOP-WORK.

THE last of the accessories of the moving power is the mechanism regulating the amount of tension to apply to the spring in winding it, and the range of development of this latter to be employed for the daily march of the watch. This part, of all others, is the most open to controversy as to the best mode of attaining its purpose; and as to the way of its execution there is a great variety, from its total omission to the rather complicated and ingenious stop-works of some Swiss and French watches.

41. When we attempt to establish the relative merits of those different constructions, there is an important feature which may guide our judgment. This is the friction; and all stop-works whose parts move under the control of a frictional resistance, may be objected to; because friction, however slight it may be, if it can be avoided, is a useless loss of power. Besides, in all the stop-works of this kind, it is a tooth or finger only, which, by butting against the full part of the stop-wheel, puts an end to the winding. This tooth or finger is liable to break under the strain it may be subjected to by the careless way in which many people wind their watches.

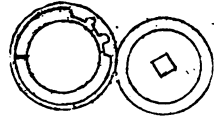

FIG. 8.

42. The most common of these frictional stop-works, though not often seen in watch-work, has a wheel in which only three or four teeth are cut, and all the rest of the periphery left full. This wheel is screwed, with a stop-screw, to the plate, and the end of the barrel arbor carries a finger or tooth gearing into it, and moving one tooth of it at each revolution of the arbor. At the beginning and end of the

winding range the tooth butts against the full part of the wheel's circumference, and prevents further motion of the arbor. It is evident that during all the time between two passages of the tooth the stop-wheel is without any control whatever, and might move round its axis by any external shocks if the freedom of its motion was not checked by a stiffening spring, causing sufficient friction. Sometimes the stop-wheel is reduced to a narrow rim, and is open at the place opposite the teeth, so that it is sprung on a little undercut stud spared from the substance of the barrel cover, thus gaining its hold without any screw or spring (Fig. 8).

43. To the same class belongs a kind of stop-work forming, as it were, an inward gear. A concentric annular groove is cut into the barrel cover, a little undercut at its outer edge. This groove holds an annular spring, in the inner edge of which some teeth are cut in which the stop-finger is to gear, and to limit the winding by coming into contact with the plain part of the spring. The friction of this latter in its groove prevents any untimely movement. It is obvious that this arrangement is liable to the same objections as the former one (Fig. 9).

44. Of the other class of stop-works, operating without friction, we mention a very judicious arrangement frequently met with in the better class of Swiss and French watches of about fifty years of age. It consists of two small toothed wheels gearing into each other; the one on the barrel arbor having some teeth more than the other one, so that the same teeth of both wheels meet only after a certain number of turns allowed for the winding. Both the wheels have on their upper side, fastened in a solid way, a stop-piece of steel, and these two stop-pieces, when meeting, stop the motion by butting in a right angle (Fig. 10). The mechanical perfection, and the reliability

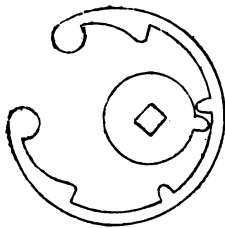

FIG. 9.

of this stop-work is beyond any doubt; and it only has the drawback that it requires an additional height for the stop

pieces placed over the two wheels, and it is easy to find that by the same quantity the breadth of the main-spring must be restrained.

45. The stop-work with the cross of Malta (Fig. 11) is the most in use for watch-work, and deserves this preference. It is too well known to require a description. It is true that the careless way in which this stop-work is often executed, in the lower classes of watches, is a source of trouble and disappointment, both to the wearers of the watches and to the repairers. It must be well understood that the Malta stop-work does not allow any meanness or neglect in its execution; but, well executed, it has a solidity up to any proof. With a judiciously arranged set of tools there is no great difficulty in manufacturing it in an irrefragable way.

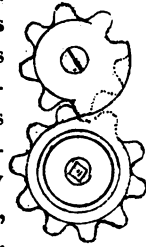

FIG. 10.

46. Still, the stop-work, however well it is made, is only an unavoidable evil, because it complicates the mechanism, and makes it more liable to disorders and failures of various kinds, and lastly, because it takes away a part of the place which might otherwise have served to increase the breadth of the main-spring.

For these reasons it is no wonder that the question has been earnestly considered, whether it would be possible to dispense entirely with the stop-work, without compromising the solidity or the steady rate of a watch, and without exposing the main-spring to any disproportionate strain. This question requires a careful study, for the advantages to be obtained from the suppression of the stop-work are of considerable importance. Thus it will only be necessary to investigate whether these advantages are not outweighed by some grave inconveniences.



FIG. 11.

47. The omission of the stop-work has been tried in a manifold way. It is more than twenty years since, that a spring was employed for this purpose, to the outer end of

which was riveted a piece of the same spring, of a length equal to about one-third of the inner diameter of the barrel. This piece was fixed backward in the direction of the spring, and its free end was resting against the hook in the barrel of the ordinary shape. This arrangement allows the spring to be coiled up to its outermost extremity, and the short piece riveted to it will then rest in an oblique direction against the hook, and prevent any farther winding. (Fig. 12.)

This system is superior to the simple omission of the stop-work, because it preserves the spring much more against breaking; but it does not protect the other parts of the movement from the sudden strains resulting from inconsiderate winding; a fault, though, which may be urged against any of the kinds of stop-work hitherto referred to.

This arrangement looks rather primitive, but it ought not to be totally rejected. I was desirous of obtaining a correct idea of its merits, and constructed, about sixteen years ago, two small ladies' watches, which had to be very flat, with barrels of this kind. These watches have been kept in constant use by persons in my immediate neighborhood, and thus I have had them under constant observation all this time; they gave satisfaction as to the rate of going, and none of the springs have been broken at the present time.



FIG. 12.

I recently saw some watches of American origin, the barrels of which were arranged in quite a similar way, with the only difference that the piece riveted to the end of the spring had two pivots at its free end, the one of which moved in a hole through the bottom of the barrel, and the other in the same way was held in the barrel cover.

48. Some years ago a system was invented by which the weak points of the one just mentioned are avoided, and the stop-work entirely dispensed with. These are the *free springs* of Mr. A. Philippe. An examination of their advantages, and of the objections raised against them, will not be out of place here.

These free springs are made or arranged in such a way as to take their hold in the barrel without the usual hook, merely by the greater tension and strength of their outer coil, which, for this purpose, is about double the thickness of the acting part of the spring. The relative thicknesses of these two parts must be kept in such proportion that the outer coil, always keeping a frictional hold in the barrel, follows the winding movement, but only when the spring has attained a certain maximum of tension. Thus,

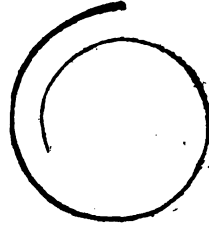

FIG. 13.

any tension of the spring beyond this maximum is rendered impossible, if the winding is continued ever so long (Fig. 13.)

49. The springs of this kind have been, and may be executed, in two different ways. According to the one, the thicker part is a part of the spring itself; while the other way consists in adding to a spring of the usual kind a separate piece of greater strength, equalling in length the inner periphery of the barrel, and forming, as it were, an elastic bridle for the main-spring, which is attached to it by a hook (Fig. 14). The effect of the two dispositions, of course, is the same.

50. It is not easy to pronounce briefly an opinion for or against the free spring; for, judging equitably its merits, we have to consider its drawbacks and the objections raised against it by watchmakers and repairers, and balance them against the advantages it promises. These latter are:

1. Greater height of barrel, allowing to employ for a watch of the same size a broader and thinner main-spring, which is consequently less exposed to accidents, and gives a more uniform traction.

2. Economy in the manufacturing of the barrel. This advantage is, however, in a degree absorbed by the higher price of the free spring, but this price will be considerably reduced if the free spring should become a regular article of trade.

3. Complete elimination of all derangements of the watch, resulting from defects or disorders of the stop-work.

4. Protection of the movement against all injury arising from inconsiderate and rough winding.

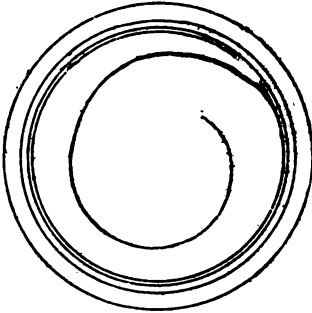

FIG. 14.

5. Lengthened period of daily march with once winding, because the free springs generally are made so as to admit a tension of six turns or more.

These advantages, especially those from 3 to 5, are of great importance, and especially the one No. 4 has not yet been so much appreciated as it ought to be.

51. The drawbacks of the free spring are the following:

1. The absence of distinct perception, marking the end of the winding operation. This objection can be removed by cutting three or four vertical grooves into the inner cylindrical surface of the barrel, and by giving the end of the spring a slight bend outward, so that it penetrates a little into one of these grooves. If the maximum of tension of the spring is attained, the end of the spring will no more be arrested by the hold in the groove, and slips into the next one, thereby giving an easily audible click, which is a warning that the winding is completed. This sudden little motion is at the same time perceptible to the touch.

2. The great inequality of traction, which must necessarily exist between the two extremities of the development of the spring. This objection seems to be a serious one at first sight, because the watch, if not regularly wound, will continue to go till the tension of the spring is almost exhausted; and it cannot be doubted that in the last hours of expiring march, the watch may show some alteration of rate as compared with the rate it keeps when regularly wound. But every one will admit that no watch can be expected to perform in an irreproachable way if it is subjected to such careless treatment; besides, let me ask, what would be the consequences of a neglect in winding a watch provided with the stop-work?

It would lead to a total stopping of the watch—a rather disagreeable occurrence, especially when traveling; and it is precisely under exceptional circumstances that the winding is most likely to be forgotten. In such a case, the owner of a watch with the free spring would have to acknowledge it as an advantage that his watch maintains its march, if even with a deviation of some minutes, which, however, would be hardly possible with a good watch, even under such uncommon circumstances.

52. Thus, the two principal objections against the free spring are completely attenuated. But there are several practical difficulties which make most watchmakers averse to its employment. This is chiefly the inconvenience of being obliged to keep an assortment of free springs, besides the stock of common springs for cases of breakage, and the higher price of the free springs adds to the weight of this argument. Springs of the common kind, on the contrary, are cheap and easy to procure.

These circumstances made me reflect whether there was not some means of enjoying the incontestable advantages of the free spring, without resigning the facility of replacing a broken spring of the usual system. I think I have found out a remedy; at least one available in case of need. I take a common spring of suitable breadth and thickness for the barrel, and I break off a piece of the outer end and corresponding in length with the

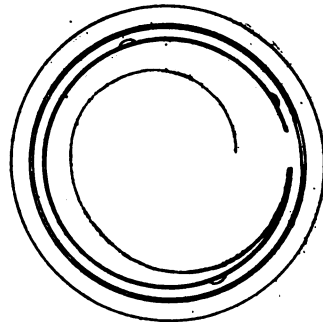

FIG. 15.

interior periphery of the barrel. Out of the end of this piece I form a hook to which the spring is hooked in the common way, so that the detached piece extends backward in the direction of the length of the spring (Fig. 15).

This arrangement has the effect that the pressure of this piece against the inside of the barrel increases with the

tension of the spring, while with Philippe's arrangement, the traction of the spring diminishes the friction of the outer turn; and this is the reason why this latter contrivance requires the detached pieces stronger than the spring itself. In the modification just mentioned, a piece of the main-spring itself is sufficient, and its resistance may be increased by the grooves in the barrel, and by a projection punched at the end of the piece, and lessened by shortening the same. I think a spring arranged in this way would soon make friends, because it offers all the advantages of the free spring, without its difficulties for the practical repairer. At any rate, it offers the means of providing a watch, in which a free spring is broken, with a new spring in suitable conditions, from the ordinary stock of springs on hand.

CHAPTER V.

THE TRAIN.

THE first condition for the construction of the train of a watch is, to make it of as large dimensions as the diameter of the movement will admit of. The very limited space allowed by the reigning taste for the movement of a portable time-keeper is already an impediment to the attaining of a high degree of perfection in the gearings; and if it is possible to execute the wheels and pinions of a clock with a satisfactory degree of accuracy, it gets more and more difficult to do so according to the smaller dimensions in which the work is to be executed. If we had the means of verifying easily the accuracy of the division and rounding of our small pinions, even of the best make, we would soon come to the conclusion that it must necessarily diminish with their dimensions. The inequalities and alterations of shape by the stoning and polishing will be nearly the same with a large pinion as with a small one, only the small one suffers proportionally much more under them. This applies to the manufacturing of the pinions; but before the pinion runs in the train, it has to pass through the finishing process. The finisher, first of all, will have to verify whether the pinion runs perfectly true, and to set it true in case of need. In all operations of this nature the operative has to rely on his eye for distinguishing whether the state of the piece is satisfactory. But the eye, like all the senses of man, is reliable only within certain limits, and if a good workman pronounces a pinion to be true, this statement must not be taken mathematically; it can only be understood so that an experienced eye can no more detect any deviations from the truth of running. There are, then, in any piece of workmanship some small defects escaping the most experienced eye, and their absolute quantity is about the same for the large

pieces as for the small ones. Let us suppose, for instance, that a careful workman, when turning a pinion of 3 m. diameter, cannot perceive any defect of truth beyond one-hundredth of this size—say 0.03 m. The same defect, indistinguishable to his eye, with a pinion of 1 m. diameter, will be not one, but three-hundredths of it; consequently it is of threefold more importance with the small pinion, taken proportionally.

The same considerations will, to their full extent, apply also to the correctness of the depths, or gearings; and it will be clearly seen that it is of the greatest importance to construct the acting parts of the train as large as the diameter of the watch will admit of.

54. Another matter of great importance is the uniform transmission of motive power from the barrel, through the train, to the escapement. This uniformity can only be attained by good depths; and as it is well known that the depths are more perfect with the higher numbered pinions, it is advisable never to have the center pinion with less than 12 leaves, the 3d and 4th wheel pinions with 10, and the escape pinion with 7 at least. The difference resulting therefrom in the cost of manufacturing is so very trifling that it could not be an obstacle to making even low class watches with these numbers.

The center pinion, it must be admitted, will be more delicate, apparently, and more liable to injury by the sudden jerk resulting from a rupture of the main-spring, or by the pressure occasioned through careless winding. The teeth of the barrel, too, being necessarily thinner, will be more apt to bend from the same causes; but this is partly remedied by the fact that with a pinion of 12 there are in almost every movement two teeth of the barrel acting at the same time on two leaves of the pinion; while in the lower numbered pinions one tooth alone has to lead through a more or less extended angle. Thus, any sudden shock will be divided between two teeth of the pinion of 12, and sustained in the same way by two teeth of the barrel belonging to it, whereby the apparent danger is greatly diminished. Besides, the finer toothing producing a better transmission of power, a weaker main-spring

may be used, and in the case of its rupture the shock will be less violent.

55. One of the chief conditions for a good and regular transmission of power is a good and suitable shape of the wheel teeth; and it is astonishing to see in what an indifferent way this important matter is treated. It is a well known fact that the wheel teeth, in order to act properly, ought to have an epicycloidal rounding, and no engineer would suffer any other form for the teeth of star wheels. Berthoud treated this subject in the most elaborate way about a century ago; Reid and others have also explained the principles of the construction of toothed wheels most explicitly, but in vain. It seems that the greater part of the Horological community have resolved to view the shape of their teeth wheel as a matter of taste. All the wheels of English and other makers have, with very few exceptions, their teeth of a shape defying the rules of Berthoud, Reid, and other leaders; a shape of which nothing can be said, except that they look very nice in the eyes of those that make them, or those who use them, and say, "They look much better, indeed, than those ugly pointed teeth." There is no possibility of being successful against arguments like these, and I have known many a respectable and good watchmaker who declared that he could not bear the sight of epicycloidally rounded teeth.

56. The respective proportions of the wheels of a train ought also to present a certain harmony, attainable by a regular progression in the diameters of the wheels and the finess of their teeth.

57. With respect to the escape pinion, at least for the larger watches, I would strongly recommend to have it of 8 leaves, with a fourth wheel of 75, and an escape wheel of 16 teeth. The last depth, the most sensitive of all to any irregularity of transmission, will be found greatly improved by so doing.

58. The following are the sizes of a train, which, according to my opinion, would answer perfectly to the above conditions, for a watch of 43 m.—19 lignes Swiss, or 14 English size:

Diameter of barrel (25)	43.0.485=20.85	m.
Centre wheel	- - -	15.4 "
Third "	- - -	13.0 "
Fourth "	- - -	11.8 "

The numbers would be:

Barrel,	90 teeth,	Pinion,	12.
Centre wheel	80 "	"	10.
Third "	75 "	"	10.
Fourth "	75 "	"	8.

The sizes of teeth are accordingly:

Barrel	0.345	m.
Center wheel	0.30	"
Third wheel	0.27	"
Fourth wheel	0.24	"

It is easy to see that this progression is a very regular one.

59. The train ought to be arranged in such a way as to have the seconds circle at a suitable place on the dial. This circle, of course, ought to be as large as possible, for the sake of distinctness of the divisions; and, on the other hand, it ought to be so large as to cover entirely the VI. of the hour circle. It may be recommended as a good disposition to have the centre of the circle of seconds exactly in the middle of the distance from the center of the dial to its edge. The general observation of this rule would be a decided step towards a greater regularity of construction, and, besides, it would prove a great boon to all the dealers and manufacturers of dials, and to the repairers who have to replace broken dials.

A greater circle of seconds might be attained by approaching its centre nearer to the centre of the dial, but this subordinate advantage would be too dearly purchased at the expense of the commodious arrangement of the wheel work.

60. The height of the moving arbors ought to be restricted only by the height of the frame. The longer the distance between the two bearings of an axis can be, the better it will prove for the stability of the moving part, as well as its performance. The same amount of side shake required for free action will influence the pitch of a long pinion less than that of a short one.

The diameters of the pivots in watch-work could not be made according to the generally established rules in the construction of machines, for if we should attempt to make the dimensions of our pivots in a theoretical portion to the strain which they have to resist, we would obtain pivots of such extreme thinness that they would be very difficult to make and

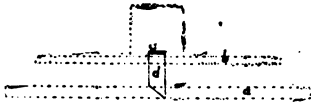

FIG. 16.

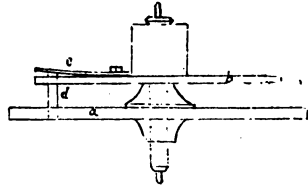

FIG. 17.

to handle, and it would be doubtful whether the cross section of such a pivot would not come into an unfavorable proportion with the molecular disposition of the steel. Besides it ought always to be kept in mind that the pivots of the train must not be calculated to bear with safety the mere pressure of the main-spring, but also the sudden strains resulting from rupture of the spring, or from rough winding. Thus, there will be very little to say against the way in which the pivots of watch-works are generally made.

61. There remains a word to say on an improvement of recent date. It has already been mentioned (54) that the centre pinion and the barrel are in constant danger of having their teeth bent or broken by the sudden jerk of a breaking main-spring. These accidents are so troublesome, that a number of little contrivances have been made in order to avoid them. It will not be useless to give a look and a thought to these inventions, and to consider whether they are really what they ought to be.

62. There is one of these precautions consisting of a kind of elastic transmission on the third wheel. This wheel (Figs. 16 and 17) is fitted with a collet, loose on the pinion, which carries a disc, *b*, riveted to it. On this disc is fastened a spring, *c*, with a perpendicular arm, *d*, which extends towards the third wheel, and reaches the arms of this wheel with its end,

thus carrying the wheel with it while the watch is going. The end of the arm has a slight slope, and when the spring breaks it is expected to slip over the arm of the wheel by the violence of the shock, and thus to stop it. I should not advise the use of this safety apparatus, because I think it will fail by the inertia of the parts between the third wheel and the main spring. The destruction, by a sudden jerk, will be completed before its power reaches the third wheel, in a like manner as the blast powder in a hole made in solid rock, and stopped up with a little clay, will split the rock by its sudden action before it has time to drive out the small stopping. Besides, this arrangement, if it should have any chance of success, must have the spring exactly regulated, so that it does not yield to the pressure of the main-spring when fully wound, but that any pressure beyond this will make it slip over. If this be not the case, the safety of the centre pinion will not be attained; and, if it be, by any excess of pressure, by inconsiderate winding at the end of the operation, will make the spring run over, and the result of this would be a deviation of rate. Now, I think the wearer of a watch will find an irregularity of its performance, a fault of much more grave character than an occasional accident, which he knows to be out of connection with the time-keeping of his watch.

63. Other contrivances promise better success, because the regulating resistance is in the centre pinion. This latter has a rather large hole, and is adjusted on a staff or axis, to which the wheel is riveted, the pinion being held fast on the staff by a screw nut and a washer. This pinion, if it is set in motion, performs like a solid one, owing to the frictional resistance which keeps it to its staff, being a little in excess of the strain effected on it by the moving power; but any addition to this strain causes the pinion to move independently of its staff, and thus to counteract the strain without injury to any of the acting parts. It will be readily understood that this disposition protects the centre pinion and barrel teeth, not only against the sudden shocks of a breaking spring, but also against any unequal strain in winding, and all this without any alteration of the time shown by the watch (62).

However, this contrivance has also its weak side. The centre pinion, with its large hole, especially when it is of a lower number than 12, has too little stock left between this hole and the bottom of the teeth, and thereby the solidity is endangered from another side. Therefore it will answer in the case of a watch the hands of which are set at the front, but it will hardly do for the hollow centre pinions used for setting the hands on the back.

64. I recently had in hand a similar safety center pinion of English make, also a staff on which the pinion was screwed with a three headed screw. Tapped into the hole of the pinion, and cut on the staff, this screw, which must be a right-handed one, if the centre wheel is above the pinion, and a left handed one, if it is below the pinion, is kept tight in the ordinary course by the pressure of the motive power. But when a backward shock is applied to the pinion, it unscrews, thus obviating any injurious effect. This method, though it appears very effective, is still open to several serious objections. The additional strain at the end of the winding operation is not counteracted, but tends to screw the pinion still closer, so that it is doubtful whether, in case of emergency, it would break or unscrew, especially considering that the pinion itself, by the large dimension of its hole, is rendered rather frail. Besides this there is no saying from which side the shock of the breaking spring will come. If the spring breaks near its outer end, the shock will apply in the way of the regular tension of the spring, and the safety apparatus will be of not the slightest use; on the contrary, the pinion weakened by the large hole, will stand a poor chance. It will only be effective in case of the spring breaking near its inner end.

65. There is a general demand for anything effecting a guard against accident to the centre pinion, and every thinking manufacturer ought to make this an object of his reflections. Still, it seems the right thing is not found yet. The best contrivance is certainly that of adjusting the pinion on a round and slightly taper staff, and to hold it fast by a screw nut and washer; but it has the objection of diminished solidity of the pinion itself against it.

66. I never felt a temptation, however, to apply it to any watch of my own manufacture, as I believe that there is a plainer way of obtaining the purpose. First of all, it will lead in the direction of having, by observation of the preceding principle concerning barrel and train, a main-spring of comparatively great length and little thickness. In case of breakage, the shock resulting from it will be less injurious, and in winding it the interposing of the stopwork will be more readily felt than with a strong stubborn spring.

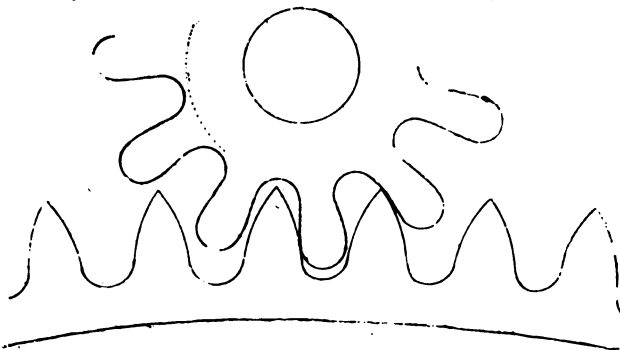

FIG. 18.

Secondly, I think it advisable, and practically possible, to strengthen the teeth of the centre pinion and barrel by giving them a shape more appropriate to their functions. Whenever one of these teeth is broken, the fracture invariably takes place at the bottom, where it is thinnest, and has two sharp corners, required by the taste of the great majority of watch-makers. An alteration of this shape would give the teeth about double the strength, as it will be evident when looking at the dotted lines marked *a* in the cut, without interfering in any way with the service of the parts. I feel persuaded that the general employment of this form for the teeth of barrels and centre pinions would serve the purpose very well, though it is not pretended that a complete guarantee against fracture would ensue from it; but in this point all the other contrivances are equally doubtful.

CHAPTER VI.

THE MOTION-WORK.

THERE is not much to say about the construction of this part of the movement, because it is, to a certain degree, independent of the proportion of the train. In Swiss watches the motion works are generally much smaller than there is any necessity for making them. With the employment of the free springs, however, there might be some advantage in very small motion work, because the barrel heads of that kind have no shoulders allowing the necessary space for the hour wheel.

68. There are some trifling matters in motion-work open to reform. In English watches, even of the better makers, the minute wheel moves mostly on a brass pin, driven rather carelessly into the pillar plate; an execution altogether unworthy of the character and general workmanship of these watches. The Swiss watches, on the contrary, down to their lowest qualities, have invariably a screwed staff on which the minute pinion is adjusted. These staffs are not easy to make, inconvenient to take out and screw in again, and by the tapping of the hole in the plate they offer less reliability of a true pitch than a round hole drilled on the pitch circle. I think there is a way between these two, which is easy of execution, and irreproachable as to solidity and diminished friction. A hole of the same size as that in the minute pinion is drilled through the pillar plate, on the pitch circle. A good round and well polished pin of hard steel, rounded at both ends, is driven into this hole, even with the plate

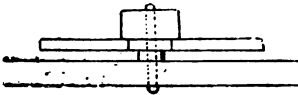

FIG. 19.

at its inner side, and projecting on the other side till it nearly touches the dial. The minute pinion has a small projecting

cannon left beyond the riveting, to hold the minute wheel at a little distance over the plate.

69. There is another matter which might easily be improved; it is the way of adjusting the minute hand to the cannon pinion. In almost all Swiss watches the hand is adjusted on the end of the setting staff, and therefore it is necessary to support the setting square when putting the hand on, least it should come out of its place by the pressure. This is not the case when the hand is adjusted on the extremity of the cannon pinion, which has a shoulder for this adjustment. Besides, this arrangement affords the advantage that the end shake of the hour-wheel can be regulated between the face of the cannon pinion and the lower end of the cannon of the minute-hand, thus dispensing with the small spring commonly in use for keeping the hour-wheel steady in its place.

70. It remains only to say a few words concerning the setting the hands, which, in most cases, is done from behind, in Swiss watches. The setting the hands on the dial side is an inconvenience almost inseparable from the nature of a full plate movement, but in $\frac{3}{4}$ plate and bridge frames there is not the slightest necessity for it. The gradual abandonment of the old style of cases, with fixed domes, and the movement accessible only from the dial side, brought the reform of the way of setting the hands with it.

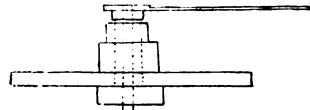

FIG. 20.

71. The dial of a watch, though of a material rather inconvenient to handle, is not much open to alterations. The liability of injury to the enamel dial has led to many endeavors of replace it by some more appropriate material. But the principle consideration of a good dial, distinctness, has never been attained in such perfection as with the enamelled ones. A perfectly white surfaces, with deep black figures on it, cannot be surpassed for this purpose. Silver dials, which were intended to supplant enamel, have nearly the same whiteness when new, but they are very liable to get dark from atmospheric influences or careless handling. Gold

dials have also been tried, but being much less distinct, and especially a gold dial with gold figures and gold hands, they may be considered a nuisance, as in any place where it is not broad daylight, and to any person who is not endowed with a very sharp sight, it is impossible to derive any benefit from a watch fitted out in that way.

For these reasons, the enamel dial, in spite of its fragility and additional thickness, is, and will be kept in use by all those who do not leave out of sight its principal purpose; but it cannot be denied that the invention of a metallic, or other more appropriate material, possessed of the indispensable qualities, would indeed prove a great progress in practical horology. There is ample room for useful inventions. There was a period when, in England and elsewhere, dials were preferred of a yellowish or greyish tint. These are, of course, not so fit for the purpose as pure white enamel. In this same way, the slightly frosted surface of the English dials is thought a great improvement, as it is said to allow of a looking at the watch in any direction without being disturbed by the reflection of the dial surface. This is a strange mistake, for if the dial of a watch does not reflect, when held in an awkward direction, the glass over it certainly will do so. Besides, it is so very easy to look at a watch without any danger of annoying reflection.

72. The fastening of the dial is effected in this direction by pins or screws. It is not advisable to fix the dial with two small screws and holes drilled through it, because the dial is very much exposed to injury by the slightest sideward pressure when shutting the case—the holes being so very near the edge of the dial. This method of fastening dials was formerly preferred by the best French and Swiss makers, and many a fine dial has been spoiled by it.

Another way of fastening the dials is with pins. It is quite efficient, and involves no danger; therefore it has much in favor in English watches, and if the movement can be got at there is nothing to be said against it. But in the movements of the present period, the greater part of which do not open with a joint, the fastening with pins would be rather

troublesome, because, for taking off the dial, it would be necessary to take the movement out of the case.

In all movements cased in this way, the dial pillars ought to be held by key-screws, which allow taking off the dial without removing the movements.

A very good method of fastening the dial is to set it in a thin rim of silver or gold, and adjust this rim nicely on the outer edge of the pillar plate.

73. The hands, in order to be distinctly seen, ought to be of a dark color, and the generally adopted blue steel is far preferable to gold for this purpose, and the figure and hands ought to be a little more substantial than the present taste prescribes for them. The most convenient shape for the purpose is the spade pattern; the Breguet and the Fleur-de-Lis hands not being easily distinguished.

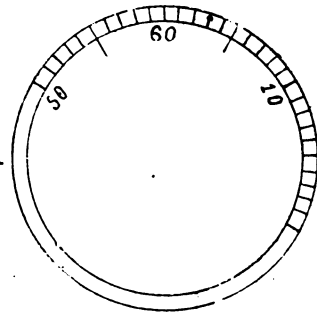

FIG. 21.

74. The circle of seconds ought to have every fifth degree visibly marked by a longer and stronger stroke, in order to facilitate the reading of the seconds.

Formerly all the dials had flat seconds, but for about thirty years it has been quite common to have sunk seconds, even for inferior watches. There is some advantage in that, especially in flat watches, where it affords accommodation for the seconds-hand, but at the same time it weakens the dial considerably. This may be the reason why some makers have the sunk part much smaller, and the seconds painted on the main dial, the lines extending inward to the end of the sink. The seconds-hand is then shorter, and moves in the sink. The dial ought never to be made larger than the pillar plate.

CHAPTER VII.

THE ESCAPEMENT.

IT cannot be the object of this treatise to describe and illustrate the various escapements, or to discuss their relative merits. We have merely to occupy ourselves with the exterior parts of construction, which serve to bring the escapement in its place, and to keep it steady there.

76. To begin with the horizontal or cylinder escapement, I always thought the "chariot," a movable fastening of both the balance cocks, a rather superfluous complication. If the distance between the cylinder and the wheel has been correctly pitched, it is only desirable to keep it intact, and the movability of the chariot is a danger for the good performance of the watch. On the other hand, no one will pretend that the correct pitching of a cylinder escapement will at first be a very difficult job, while the duplex escapement, requiring by its delicate nature the most perfect accuracy, is, in the majority of cases, planted without movable chariot; besides, the cylinder escapement admits, more than all the other escapements, of being manufactured and planted by the system of perfect identity, and it would seem advisable to take advantage of this circumstance. The suppression of the chariot would render the movement more simple, and easier of execution to a considerable extent, because the lower balance cock could then be omitted, by setting the balance hole in the same way as that of the wheel, in the bridge; or, in absence of this, in the plate itself. The necessity of the chariot is only a prejudice originated by habit and blind routine. If a cylinder escapement, then, is correctly pitched, it will be so for ever, and no inexperienced hand would be able to alter it; and as to those escapements which are incorrectly pitched, they ought not to pass examination without being corrected.

77. The disposition of the cylinder escapement being not so extended as that of the lever escapement, the space in the movement is not so much occupied; therefore the train, to begin with the center wheel, can be made one size larger than in a lever movement of the same diameter, in order to secure the advantages to be obtained thereby. (53.)

78. The cylinder escapement is at this period nearly superseded in almost all countries, except France, by the lever escapement, and with respect to this latter, there are a few more observations to make.

The arrangement of this escapement admits of a greater variety; and, in the first place, the question must be settled, whether it is to be set in a straight line or at right angles. This latter system recommends itself by an economy of space, or, what is the same, by a more convenient placement of the parts. Thus it would allow the wheel, lever and pallets to be made larger for the same size movement. For the reasons alleged for the sizes of wheels and pinions (53), this might appear advantageous; but in the case of the escapement we have to consider it from another point of view. We must consider in the first place that in the intermittent action of a dead beat, or detached escapement, the inertia of the moving parts must be overcome at each vibration, and that this impediment must be reduced as much as possible. Besides, the sliding friction of the wheel on the pallet planes is of a very different nature from the rolling friction of the wheel teeth; and this former kind of friction increases considerably with the extension of the planes to be traversed. For these reasons the wheel, pallet and fork ought not to exceed certain limits in size, and they ought to be worked out as light as their necessary strength will allow. The length of the fork, too, must be restricted. I will not repeat here what I have treated in full detail in my "Treatise on the Lever Escapement," Chap. IX, p. 62. The action of the fork and roller is also not of such a very delicate nature as to make us wish to execute it on a large scale in order to verify easier its performance.

For the same reason, it is not advisable to make the wheel, or other parts of the escapement, of gold, the specific gravity of which is here an objection.

79. The arrangement of the escapement in right angle offers thus, as we have seen, no advantage by its economy of space, except in complicated constructions, where the space is restricted by other parts of the mechanism. It may be considered but little more than a matter of taste to employ the one or the other arrangement, still there is a slight difference in favor of the escapement in right angle.

The pressure which is acting on the pallet pivots may be considered a threefold one: 1st. The pressure of the wheel on the locking faces. This is exerted with the full power of the escape-wheel, and acts on both arms in the direction of a line drawn through the locking edge of the entrance-arm to that of the other arm, and will tend to wear the pivot holes in the direction of the second arm. 2d. The pressure resulting from the decomposition of the force of the wheel when acting on the inclined planes of the pallet. It is, of course, much weaker, but it acts during a more extended angle of movement. It increases with the lifting-angle, and has a tendency to widen the holes in the direction of a straight line from the center of the wheel towards the center of the pallet. 3d. The reaction of the resistance in unlocking. It acts alternately to both sides of a line at right angles with the line joining the centers of balance and pallet. Both the effects under 1 and 2 take place equally, and in the same direction, for any lever escapement; but the third one coincides in direction with that under 1, if the escapement is in straight line, while, with the escapement in angle, it falls into the direction of the one under 2, which is essentially weaker.

It will easily be seen that this difference is hardly of any practical importance; at least not sufficiently so to render it unadvisable to construct escapements in straight line.

In all cases of this latter construction, the pallet holes, as a rule, ought to be jewelled; because the bushing of a worn pallet hole in a straight line escapement is more troublesome than in another one, as any deviation of the exact pitch must

necessarily here produce a defect in both the actions of wheel and pallet, and of fork and roller.

80. According to the foregoing demonstrations, the diameter of escape-wheel in a lever watch ought not to exceed one-fifth of the diameter of the pillar-plate, and then it will be a good proportion to have the acting length of the lever—that is, the distance from the pallet center to the acting edges of the fork—equal to the wheel's radius, or one-tenth the diameter of the pillar-plate.

With these proportions the pallet center will be within the circle of balance, if this latter is not disproportionately small.

81. There might be found a trifling economy in having wheel and pallet under one and the same cock, but then we would have either to renounce the advantages of a short lever, or to make the escape-pinion as short as the pallet-staff which is to lie under the balance. This ought to be avoided, because the stability of the axis is greater when the pivots are far apart (60). Therefore, the little additional trouble or cost of making a separate cock for the wheel ought not to be an objection.

82. The action of the fourth wheel into the escape-pinion ought not to be placed too high; for, if otherwise, the good service of this depth, by its nature the most imperfect and most delicate of the train, might be endangered by the slightest alteration in the steady pins of the escape-wheel cock.

For the same reason this cock ought to be placed so that a straight line through the pivot hole and the screw hole points towards the center of the fourth wheel, or nearly so, because then any bending of a steady pin will influence the depth in a less degree.

83. The balance-cock, in the course of making or repairing a watch, must be very often removed and put on again; therefore it is of great importance to pay much attention to its steady pins, for, if badly made, they give much trouble. A well adjusted cock, especially that of the balance, ought to be firm in its place; it ought to go easy into the steady pin holes till at a distance of some tenths of millimetre, and then be so firm that the escapement may be safely tried without using

the screw. This result can only be attained by steady pins of a conical form. I would not recommend the English way of screwing the steady pins in, because it is not so easy, and does not offer the same surety of exact fitting as a pin driven into a round hole. The following is a way to do it which I always found to answer perfectly well. I take a piece of wire, a little thicker than the hole, and file it to the ordinary taper of a broach, till it will enter about half way into the steady pin hole in the pillar-plate. Then I take a burnishing file, and, holding the pin with the pin-vice in a suitable groove of the wood in the bench-vice, I apply the burnisher to its end, so as to burnish a length, a little more than the thickness of the plate, into a more conical shape than that of a broach. After this, if properly done, the pin will enter fully into the hole in the pillar-plate. Then I take a good broach and make the corresponding hole in the cock wider till the pin, thus prepared, goes in far enough to have its extremity level with the lower surface of the cock. This, however, is a matter of experience, because it depends on the relative hardness of the cock and of the pin-wire. Then I cut the wire off, leaving a sufficient length projecting at the upper surface of the cock, and then, after putting the lower side on a piece of flat steel, with a hole in it only a trifle larger than the pin, I drive the pin tightly in, trying it from time to time into the hole in the pillar-plate till it holds the cock fast. The other pin is made in the same way, and a cock, well fitted according to this principle, goes on quite easy till the pivot is in the hole, and then it gets more than sufficient hold by the last pressure, which may be exerted safely and without injuring the jewel hole. These conical steady pins offer the additional advantage, that a small bending of them will not affect the position of the cock; because, in consequence of their taper form, they catch their hold in the plate merely by the part next to the cock, while the parts of the pin exposed to bending are free in the hole.

84. Two steady pins, well adjusted, are quite sufficient, and much better than three pins made in the common careless way, with which a cock often goes on rather hard at the beginning, and allows some shake when close down to the plate.

The steady pins ought not to be too long, for if they are they bend too easily. The length must not exceed double their thickness, and the pin-wire must be drawn as hard as possible. To be effective, they must stand as far apart as the foot of the cocks will allow of.

85. The balance is a part, the dimensions of which show very great variety in watches, and without undertaking here any dissertation on this subject, I will restrict myself to stating that I believe it a good proportion to multiply the diameter of the pillar-plate with 0.4, or to take four-tenths of it as the diameter of the balance. With a movement of 18 size, or 44 m., this would be $44 \times 0.4 = 17.6$ m.

86. If the movement is to have a compensation balance, great care must be taken to have ample space for the inside and outside of the rim. I have noticed many cases of inexperienced workmen being nearly driven to despair by a watch apparently in the most satisfactory state, and performing quite well, but at the beginning of the cold season stopping regularly every night. When being examined, of course in a warm room, the watch resumed its ordinary march without showing the slightest disorder, till it was found out that the expansion of the balance brought it into contact with a cock, or other part too near its circumference.

CHAPTER VIII.

THE CASING.

THE method of casing presents a variety of features, and necessarily varies according to the style of case; therefore, in order to settle this point, we must first decide on the best plan of case.

There is, first, the old English style of case, with a fixed dome; the hands to be set, and the movement to be opened, from the dial side. In this kind of case, the movement is fixed at the 12 with a joint and held in its place by a catch at the 6, which, for opening, can be pushed in with the nail of the thumb. This method makes, undoubtedly, a good strong case, but it has many inconveniences for the wearer of the watch. For winding the case must be opened from behind; and for setting the hands it requires to be opened on the dial side. A very bad feature of this arrangement is the opening of the movement by means of the catch; a slipping off from it of the nail of the thumb has caused the ruin of many a good seconds or minute hand. A case of this kind may be employed for a full-plate movement, in which, by its nature, the hands must be set on the dial side, but any $\frac{3}{4}$ plate or bridge frame ought to have the setting square behind. (70.)

88. For this latter kind of watches the modern form of case will be the most convenient. The movement is fixed to the case by one steady pin and one, or two screws—the latter being best. The Swiss watches generally have three pins driven into the edge of the pillar plate at some distance from each other. The middle one of those is the strongest and of a square shape, and partly enters into a small recess in the rim of the case, thereby preventing any circular displacement of the movement, and the outer end of it, filed sufficiently down from its upper side, takes hold under the rim as well as

the two side pins. This mode of fixing the movement generally with only one screw, is rather troublesome in putting in and taking out the movement, especially with the very thin cases of so many Swiss watches.

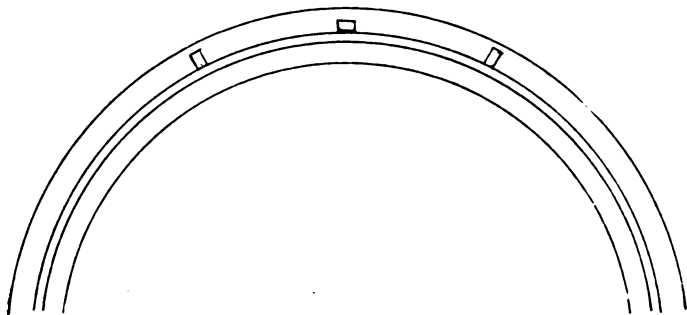

FIG. 22.

89. Therefore, I propose another plan, which, if the pillar plate and its shoulder be properly fitted into the rim of the case, will answer completely, though of very simple and easy execution. A hole must be drilled through the upright part of the rim surrounding the pillar plate, into this plate. A pin driven into the hole in the plate, and shortened so as to enter into the rim without exceeding its outer side, serves at one and the same time to hold the movement down in its place, and to prevent any side displacement. Two common key-screws, each 120° , or $\frac{1}{3}$ of the circumference apart from the pin and from the other screw, and taking their hold on two studs, soldered to the inside of the rim, complete the fastening.

90. The pin ought to always be placed near the balance, so that this most precious and delicate part of the movement comes first into its position in the case, and is not exposed to any violence when forcing the movement down on its seat. It is very essential to adjust a movement carefully into the case, so that it enters quite smoothly, and without any pressure; because, in the latter case, especially if the case is strong, and the plate thin and not hard, it might easily suffer a deflection in a sufficient degree to alter the end shake of the pinions.

91. I would not recommend to have the key screws for the casing in the upper plate and taking their hold outside on the rim of the case, because the plate is too thin to offer sufficient stock to the screw, and because this thin plate, if the screws are strongly turned in, is liable to bend. The pillars must then be considered as a fulcrum, and in the ratio as the screws bend to lift the outer edge of the plate, the inner parts will bend down, and thus diminish the end shake of the pinions.

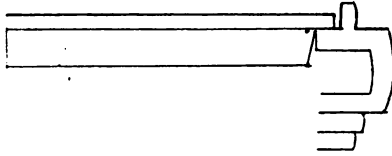

FIG. 23.

92. The movement, in the modern case, is accessible from behind by opening the dome, and as the hands are set from this side, the wearer of the watch has no occasion whatever to open the dial side of the case. In this kind of case the dial ought to be fixed with key-screws, and not with pins, else it would not be possible to take it off without previously taking the movement out of the case.

93. I often see Swiss watches, of recent make, having the heads of the casing key-screws below the dial. This arrangement has no comprehensible advantage, but subjects the repairer to the vexation of being obliged to take the hands and dial off before he can remove the movement from its case.

94. The setting square ought to be provided with a cap, as well as the winding square, in order to prevent any particles adhering to the key, from entering into the movement. Care must be taken to have these caps reach up to the inner side of the dome, and without any excess, because this would, especially in a strong case, produce a pressure on the plate when the case is shut, and which would often be sufficient to stop the watch by reduction of the necessary end shake of the pivots.

95. The cases in which the movement can be opened with a joint offer a greater convenience for the exact timing of the watch, because the timing screws of the balance are more accessible ; but this convenience is of no great consequence.

96. It remains to say a word about the contrivances having for their object the protection of the movement, or of certain parts of it, from the dust penetrating through the case. The most perfect dust cap is that of the old English full-plate watch, because it covers the whole movement, without the slightest exception. In the majority of cases it is admirably made, and effects its purpose very well. It has been tried with similar success to protect the movement of $\frac{3}{4}$ plate watches, though the dust cap, by the additional height of case it requires, does not harmonize with the modern watch. It was an absolute necessity to employ it with the old cases opening and shutting with springs, and consequently far from being dust proof. But with the gradual progress of case-making, the cases shut tighter now than they used to do, and therefore the dust caps can be entirely dispensed with. The fittings of the cases, if they are made with a little care, shut very closely, and nevertheless open and shut with ease. For this purpose the rims must not be too much undercut. The better class of English cases are generally fitted with much care and judgment. The rim ought to be slightly rounded for the smooth passage of the shutting edge of the rim over its highest point. (See Fig. 23.)

97. The dust covers in ring shape, surrounding the frame of full-plate movements, avoid the disadvantage of occupying more height in the case, but they are also so much less efficient. What is the use of protecting the train from dust, if at the same time the balance, the pendulum spring, and the counter sinks in the upper plate with oil in them, are exposed ?

CHAPTER IX.

THE JEWELING.

THE jewelings are an improvement in horology belonging to its newest period. It is evidently a great progress to introduce a material indestructible by friction, not susceptible to chemical influences, and capable of the highest polish, for the bearing of the pivots, thereby insuring the stability of their actions, the preservation of the oil, and the reduction of frictional resistance to minimum.

99. Jewel holes ought to be well examined before using them, because if the hole is not carefully polished, or if its edges are ragged, they are worse than metal holes, for they wear the pivot very quickly.

100. According to my opinion, a movement ought to be jewelled throughout. The price of a pair of jewel holes is not so high as to form an obstruction to their use, and especially the pallet holes ought not to be left without jewelling. The angular motion of the pallet is very trifling, it is true, but experience tells us that when grinding any substance, the reciprocating motion answers best of all, and the wear of a pivot in its hole is nothing else but a very slight degree of grinding. Besides, the jewelling of the pallet holes might be thought useful by the diminution of friction, and this is very essential in the lever, the inertia and resistance of which has to be overcome at every beat of the escapement.

101. For similar reasons, the third and fourth wheel holes ought also to be jewelled, if the quality and intended value of the watch will any way warrant the expense.

102. To have the escapement, that is, the wheel and pallet cap jewelled, or with end-stones, is more a matter of taste than of practical utility. In the case of the balance, with its quick vibration to the extent of about 400° , it is of the utmost

importance to avoid the amount of additional friction which would result from the bearing of shoulders against the faces of the holes, and thus the end-stones of the balance cannot be dispensed with. It will be obvious at the first glance, that the pallet and wheel work under vastly different circumstances. In a movement of the usual arrangement, the pallet makes an angular movement of 10° to 15° for every vibration of the balance, and the wheel accomplishes, if it has fifteen teeth, 12° of its rotation in the same period. Besides, their weight cannot be supposed to press so much in the vertical direction, because they are working under a continual and considerable side pressure. But the greatest difference between the position of balance pivots and that of wheel and pallet is, that these latter parts may be made as light as possible, while the balance is, and must be, considerably heavier.

103. The difference between the friction of a plain jewelled pivot and a capped jewelled one, is extremely small. According to a generally established law in mechanics, that, the pressure being the same, the amount of friction is not altered by the extent of the bearing surface, it would be *nil*. But in our case, and especially because lubrication is required, the adhesion must be considered. Anyhow, the resistance to the motion of the cap jewelled pivot can only be easier as the ratio of the difference of the bearing surface, and this difference between the surface of the pivot end and that of a properly reduced shoulder, is a trifling one. With an angular motion of more than thirty times the extent of that of the wheel and pallet, it acquires, of course, a greater importance, and therefore the end-stones are indispensable to the balance. I freely admit that there is a little economy of power in the cap jewelled escapement, but I wish only to point out that this very trifling advantage is generally overrated. The fact that a number of the best English watches are without end-stones to the escapement, seems to indicate that the English horologists look at this matter about in the way above mentioned.

104. The employment of a diamond as an end-stone to the upper balance pivot, is a very good practice, because the watch, in its horizontal position, performs with almost all the

friction on this pivot end, and the extreme hardness and fine polish of the diamond face will reduce the wear and friction to their smallest amount. It only requires some care to select the diamonds, because among those which can be bought in the material shops, there are sometimes pieces defective in the point of polish; and, in this case, instead of conserving the pivot, they might prove the means of its destruction.

105. The good and careful execution of the balance holes forms the most important point in the jewelling of a watch.

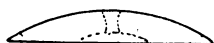

FIG. 24.

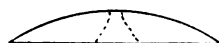

FIG. 25.

Not only must they show, like all the other jewel holes, an irreproachable polish, but they must be rounded in a proper manner in order to make the friction in the vertical and horizontal positions equal, or as nearly so as it can be done.

106. It may be considered a good plan to make the balance holes on the conical method, in order to give them a greater strength, and to facilitate the entrance of the pivot when putting the balance-cock on; but they require great care in their shape, lest the adhesion might be increased. Besides, a cock with its steady pins, made in the way previously described (83), renders it very easy to put the cock on without injuring the jewel hole.

107. The setting of the jewels is a matter of very different execution. In some, especially the better class of English watches, the jewels are set in brass or gold settings, which latter are fitted into holes with countersinks, and fastened with screws, the heads of which partly intersect the circumference of the setting, while the thread is tapped in the plate, and the head of the screw sunk into it, so as to be level with its surface.

108. The advantage claimed for setting jewels in this way is a greater facility of replacing a broken or damaged jewel without regilding the plate or cock. This, however, does not weigh very heavy, because if a good stock of jewel holes is within convenient reach it will be easy to find one fitting into

the old setting; and even if this should not be the case the purpose can be attained by setting the new jewel in a piece of brass wire of suitable thickness. This wire, after being turned exactly concentric to the hole, and of a slight taper, is adjusted into the hole in the plate, previously turned out, and then it is cut off at a length a little in excess of what it is required to be. This setting now must be gently driven into the hole in

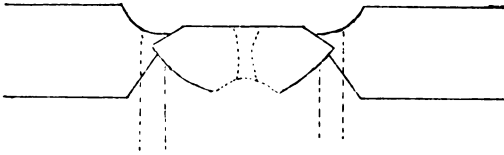

FIG. 26.

the plate till the proper end-shake is attained. The plate or cock is then cemented to a flat chuck and well centered to the hole in the jewel, after which the taper is turned. If the brass setting has been turned to a proportionate size it will be easily attainable that the taper extends a little beyond it into the plate; and in a plain jeweled watch, if well done, the replacing of a jewel in the way just described can hardly be detected.

109. A movement with plain set jewels is in no way inferior to one with screwed jewels, even, as has been explained, in the very exceptional case of the replacement of a jewel hole. The movement with screwed jewels has a more elegant appearance, but it implies, if not done with the greatest care and discernment, a vast deal of trouble in the manufacturing, and still more so in the repairing. Not only must all the screws and jewels be taken out for thoroughly cleaning a watch, and put in again, but the very little thickness in which the screws have to take their hold is a great source of annoyance to the repairer, especially in the English watches, with their thin upper plates of brass, rendered quite soft by gilding, and with screws of rather coarse threads. (22.) Any screw failing in its hold has to be replaced by one of the next number of thread, having by its greater thickness still less chance

of a sound hold, and very often it is necessary to make other holes at fresh places. If, now, the screwed jewel presents the advantage of easy replacement of a broken jewel without leaving any lasting mark of the operation, this small advantage may be considered to be neutralized by the above mentioned drawbacks.

110. However, the screwed jewellery may be improved in such a way as to make it much less liable to failure. There is not the slightest necessity for countersinking the screws in the upper plate; they might, without the least detriment to their functions, have flat heads, rounded at the top, which merely serve to hold the jewel down in its place, thereby reserving the whole thickness of the plate for the hold of the screws. The jewel setting might be dotted as usual, for always having it in the same place in its sink, which is not without importance; and if it should be thought necessary to insure this position of the jewel, even against careless repairers who might not pay any attention to the dotting, this might easily be attained by drilling a very small hole in the bottom of the countersink, into which a pin might be driven, and for the reception of which the jewel setting ought to have a small groove.

CHAPTER X.

THE FUSEE.

IN the period of the recoil escapement, the invention of the fusee was undoubtedly one of the most important steps towards perfection in time-keeping. The old vertical watch is to such a high degree under the influence of the variations in the intensity of the moving power, that it hardly deserves the name of a time-keeper if not provided with a mechanism for equalizing these irregularities. The vertical escapement was superseded by the dead beat escapements, especially the cylinder escapement. One of the principal features of this latter is, that the locking and lifting take place at equal distances from the centre of the balance. The friction on the locking, therefore, is considerable, and acts during the greater part of the vibration. These circumstances have the effect that, with any increase of the impulse power, there is a corresponding increase of friction at the locking. This friction it will be obvious, acts in a corrective way, and if the proportions of the escapement are well chosen it is in a surprisingly small degree influenced in its time-keeping by any irregularity of the moving power. The duplex escapement works under similar circumstances, while the detached escapements which no correctional friction, may enjoy the independence of their time-keeping only by a judicious arrangement of the pendulum spring.

112. To begin from the time of the clear establishment of these facts, a rather different course was taken by the leading horologists in the different centres of horological manufacturing. The French and Swiss, with their practical endowment, immediately took advantage of this changed situation, and simplified the movement by dispensing with the fusee and its appendices. This step together with some other circumstances,

was the base on which the Swiss manufacture largely developed itself, because by these means, they were enabled to produce a cheap watch of convenient and even delicate dimensions and still satisfying the wants of common life.

113. The English, on the contrary, kept to the traditional fusee movement, even under so vastly changed conditions; and even now, notwithstanding a number of advocates of the going barrel have sprung up amongst them in the latest period the majority still adhere to the belief that the fusee is an indispensable characteristic of a truly English watch. The consequence of this conservative inclination is, a well-maintained superiority of time-keeping in their better class of watches, but a gradual decrease of demand for the inferior qualities and which, in fact, have ceased by degrees to be a marketable article.

114. These are the practical and commercial consequences of the retention and the omission of the fusee in the modern watch, as experience has shown them in those two old manufacturing countries. It is strange to see that the highly creditable invention of Graham, that of the cylinder escapement, has not been a source of much benefit to his countrymen, merely because they rejected the idea of coupling its adoption with a remodelling of the movement rendered admissible by the nature of the new escapement. The Swiss by adopting this latter course, and by a thorough division of labor, have succeeded in producing a watch of satisfactory time-keeping quality, marketable by its price and elegant form and dimensions and thus powerfully raised their horological industry.

115. There can be no doubt that the fusee, with its equalizing power, insures a greater uniformity in the rate of a first-class time-keeping instrument, but the degree of superiority obtained by this means has been vastly overrated, and for the wants of common life there is no difference of any practical importance between the performance of a fusee watch and that of a going barrel one. Even if the difference between the rate in the first and the last six hours of spring development in a going barrel watch should amount to ten or twenty seconds, which is far more than ever will result from

this cause in a good watch, this would be no impediment to the watch running a general steady rate, because the error would repeat itself regularly in the course of every twenty-four hours, and it only would require to wind the watch in as regular a manner as could be afforded.

116. The employment of the going barrel allows of a stronger train of wheels and pinions, of a more capacious barrel and of a less restrained arrangement of the moving parts. It economizes power by the omission of the frictional resistance of two large pivots like those of the fusee, and it has the great advantage of not being exposed to as many accidents as the fusee movement, in which there is the additional danger of a rupture of the chain, besides the breaking of the spring. The going barrel movement, if properly constructed so as to have a thin and long main-spring, can be set going with the middle part of a total development of at least six turns; and this main-spring is not so much exposed to breaking as the thick and short spring of a barrel in a fusee movement.

117. But the greatest advantage of all is, that the going barrel movement with its greater abundance of moving power is much more than the fusee movement appropriate for a quick train, viz:—one with 18,000 vibrations in an hour. This quick vibration makes a watch much more fit for good performance, especially when worn by persons riding in carriages or on horseback, or in any other way exposed to continual external shocks. It is quite obvious that the much greater momentum of a balance in such quick vibrations, will be much less under the influence of such disturbances than another balance, vibrating one-fifth slower. This increased activity of the movement, producing 3,600 more vibrations in an hour must, of course, be maintained by a greater moving power, and in this point the fusee movement will be found deficient, if it has not an excessive height and diameter, or a very light balance.

118. The consequences of the above considerations may be condensed in the following conclusions:—

The employment of the fusee is recommendable for all watches of which the most accurate time-keeping is expected.

The going barrel ought to be resorted to for all watches not belonging to this class, and especially for the use of such wearers as have to rely on a performance as much as possible free of disturbance; for instance, travelers, soldiers, etc.

119. This point of view was most likely taken by the first watch manufacturers of the United States, when they very judiciously dispensed with the fusee movement, and which in my opinion, is a most essential element of their success.

120. Having thus exposed the nature of those cases where the employment of the fusee may be thought useful, it will perhaps not be amiss to say a word on the best mode of constructing a sound and well-proportioned fusee movement. In doing so, I cannot help stating that the historical English

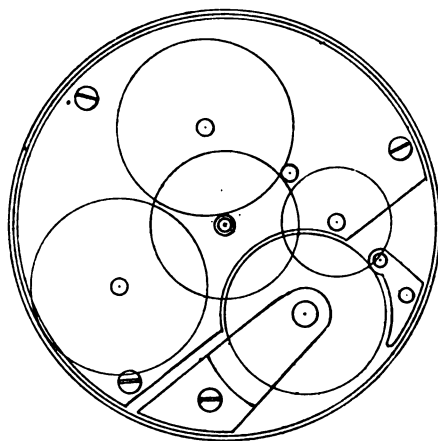

FIG. 27.

fusee movement, according to my way of viewing the matter, is not a perfect arrangement because it is not capable of containing a main-spring of a breadth proportionate to the height of the frame. This, as I intend to show by figures and diagrams, is mainly the result of the placement of the centre wheel in those movements. When I was working in London, I had some conversations about this point with very good horologists but they were quite positive in dissuading me from attempting any alteration whatever in the construction

of the fusee movement. I got up a drawing in which I could not see any mechanical defect, and was quite sure of my plan; but I had not then the facilities for carrying it out in practice. This, however, I did later, and the experiment fully confirmed my former supposition. In the hope that it may be useful to some of your readers, I give a diagram and description of the fusee movement, with comparative figures of its advantages over the English movement.

The greatest alteration in this movement is, as will be easily seen, the transposition of the centre wheel from its usual place below the barrel, to the opposite part of the frame above

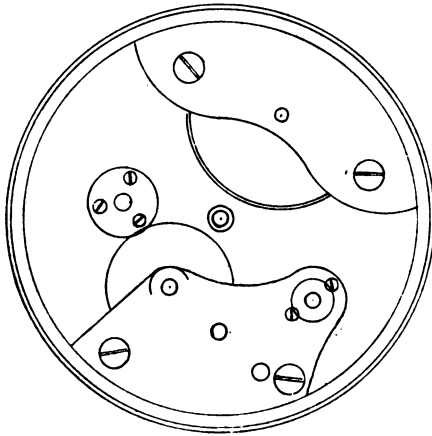

FIG. 23.

barrel and fusee. The centre wheel can very conveniently be sunk into an upper plate of proper thickness, so as to lie flat with its surface. Then the fusee may come as near the upper plate as in the English movement. The barrel cannot pass through the upper plate, as it does in the usual movements, but it can reach almost down to the dial, save only the thickness of its lower bridge. In the English movement the centre wheel is an absolute bar to give any more height to the fusee and barrel, and all the height of frame between centre wheel and dial is lost for these important organs.

For illustrating the advantages to be derived from this arrangement, I give the following comparative sizes:—

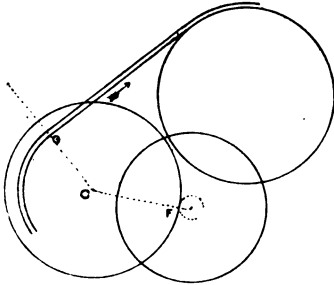

FIG. 29.

I have a good English three-fourth plate movement, diameter 44 m.; the total height of frame is 7.2 m., the height of fusee 3.2 m., and the height of barrel 2.65 m.

My movement, of the modified disposition, has a diameter of 46 m.; its height is also 7.2 m., the height of fusee 3.8 m., and that of barrel 3.9 m. The height of frame being equal in both cases, it will be evident that there is a considerable advantage in the arrangement I propose:—

	Height of Fusee.	Breadth of Spring.
In my movement.	3.8 m.	3.9 m.
In the English movement.	3.2 m.	2.65 m.
Difference in favor of the former.	0.6 m.	1.25 m.

Compared to the English movement, the construction with the centre wheel above the fusee results in a percental gain in the height of fusee, of 18.74 per cent., and in the breadth of spring, of 47.17 per cent.

This latter is an increase of nearly one-half, and I think it may be considered a most essential improvement of the fusee movement. From the following description and drawing, the reader may conclude that this gain is not bought at the price of any loss in the solidity of some other part of the movement.

The third wheel, in a movement of this kind, must get its place at the dial side of the pillar plate, under the fusee wheel. In all other particulars there is no difference from the usual position of the acting parts.

121. The respective position of barrel and fusee in all the English fusee movements is also irrational, and ought

to be inverted. This latter position of the fusee would save a considerable amount of friction on the pivots, without a loss or disadvantage on any other side.

The pressure acting on the pivots of the fusee in the English movement is, by this defect of construction, the highest attainable maximum. The diagram 29, represents the fusee wheel and centre pinion. In order to ascertain the pressure on the pivot, it must be supposed that the point of contact between the wheel and pinion at F is the fulcrum of a lever, on the other end of which G, the power transmitted by the chain is acting. It requires no proof that the pressure on the fusee pivot C is equal to double the power exerted at G.

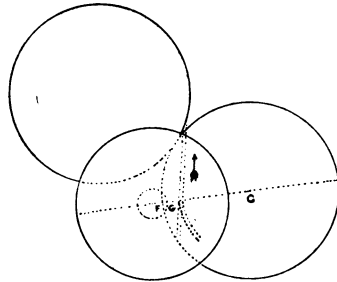

FIG. 30.

With the other plan of construction, illustrated by diagram 30, the fulcrum is the same, at F; the power acts very near it, and the pressure at the pivot C will consequently amount to about one-fourth of the power exerted at G.

The difference of pressure in the two cases spoken of is as 8 to 1; and as the friction is in the ratio of the pressure, the advantage to be attained by this modification is considerable, though it must be remembered that the difference of pressure in the two cases is in the ratio of the pressure, the advantage to be obtained by this modification is considerable, though it must be remembered that the difference of pressure in the two cases is greatest when the chain acts at the bottom of the fusee, and diminishes towards the top of it; but even there it will be about as 4 to 1.

It is surprising that this arrangement, the advantage of which is beyond any doubt, and which is due to Julian Leroy, has not found any followers in England, the country of the fusee movement. It has been employed so much the more by French and German makers.

CHAPTER XI.

THE KEYLESS MECHANISM.

THIS complement of the modern watch, so much in demand now, and, it must be confessed at the same time, so useful and agreeable, is getting so much in favor that its manufacture and construction is well worth saying a word about. Even now there is still a pronounced mistrust against it in a considerable part of the public, and there are even many respectable watchmakers who cannot resolve to advocate a keyless watch.

The keyless mechanism, though, is much more than a mere toy, or a convenience to the wearer. It is useful in many directions. In the first place, it affords the possibility of winding a watch, and of setting its hands, at any time, and in any place, because these operations do not require the opening of the case, while the winding or setting of any other watch must be done while the body is perfectly at rest, and is impossible in a carriage or on horseback, or even when walking. It cannot be done except under cover, and at a place free from dust, while a keyless watch can be treated in the open air without any fear of rain or dust. All this is more than a mere convenience, because it insures the continual service of the watch during a voyage, when the wearer seldom finds a moment of rest for winding his watch, and in these rare moments may forget to do so, or may have forgotten to take the key with him, and it is sufficiently acknowledged that a watch is doubly important when you are traveling.

123. Another advantage may be expected from the employment of the keyless mechanism, and I venture to say that it is also a very important one. The rotary motion required for winding a keyless watch takes place in a plane vertical or at right angles to that of the balance. This is a complete

guarantee against the detrimental effects of the bad, but very frequent habit, of the wearers of watches, of moving not only the key but also the watch when winding it. This practice, it will be readily understood, involves a sudden rotary motion of the movement in the plane of the balance, and which is repeated ten or twelve times till the operation of winding is completed. If, in the best case, this careless treatment does not result in direct injury to the acting parts of the escapement, it causes at least deviations of rate in a lever watch by violent banking, and those irregularities, which nobody can account for, often discredit a watch in the opinion of its owner, and are often ascribed to a want of skill or care of the repairer to whom it has been intrusted.

124. A very important consideration of the keyless mechanism is the greater durability of the cases, and their interior remaining better preserved from injury and deterioration. The oft-repeated opening wears the rims and joints of the case, and, besides, there is a necessity of not too hard shutting for the case of a key-winding watch, which does not exist with regard to a keyless one. This latter may shut more closely, and thereby protect the watch more efficiently against dust, etc.

125. The necessity of opening the case of a key-winding watch at least once every day admits the direct entrance of dust. The key also, in the majority of cases, is a very active agent for the introduction of filaments and impurities of all kinds, owing to the bad practice of carrying the key about in a waistcoat pocket, which nobody thinks of cleaning.

126. For the purpose of studying and comparing the different keyless mechanisms, it will be indispensable to classify them into certain groups, lest the great variety of these contrivances could not be conveniently inspected.

The greatest part, and, in fact, almost all keyless watches may be divided into two principal categories:

1. Those with which the setting of the hands is done by devices arranged on the winding arbor and shifting on the same.

2. Those who accomplish this result by means of a rocking plate.

127. The last mentioned class, indispensable for fusee watches, is of a more delicate nature, and requires a more careful execution. The former, therefore, is more resorted to, especially in Swiss watches. In considering this first class of keyless mechanisms a subdivision may be easily established between those where the hands are set by pulling the winding knob a little outward, and those provided with a push-piece for putting the hands in motion.

128. This latter class, in the majority of cases, are executed with the so-called kregnet-action, that is, they wind the spring when the knob is turned to the right, and perform a click action without any effect when the knob is turned the other way, thus affording the advantage that any inconsiderable effort for turning the knob the wrong way cannot do harm to the mechanism. The kregnet click, however, is not an essential feature of this form of keyless mechanism.

129. The winding knob, in the majority of keyless watches, is connected by a square or other adjustment with the winding pinion, the arbor of which passes through the pendant, the pinion part being in the rim of the case. By this arrangement the barrel arbor, on which the operation is to take place, is situated vertically, while the pinion stands in a horizontal direction, and these two moving parts, therefore must be connected by an angular gear. In most keyless watches this gear is composed of a straight pinion and a contrite or crown wheel. These, however, constitute a very imperfect transmission of force, because the teeth of the contrite wheel, being cut in the radial direction, can only agree in one point of the action with the direction of the pinion teeth viz., when the side of the tooth is in the line of centres. During the part of the action which takes place before and after the line of centres, the pinion tooth works against the outer or inner edge of the tooth, which is certainly not an advantage for both parts. The detrimental effects of a gear of this kind will be the more considerable with a pinion of low number, because its teeth lead through a more extended angle.

130. For these reasons it is preferable to employ a conical gear, as offering the best conditions for a regular and smooth

transmission of power, and for the durability of the parts. A conical pinion, too, can be executed much stronger than a straight one. There is, indeed, almost an impossibility of practically executing a conical wheel and pinion of perfectly theoretical shape of teeth, but in the way they are commonly made they are quite fit for service, and far superior to the straight pinion and contrite wheel.

131. One of the best keyless mechanisms, on account of its simplicity and durability, has the following general features:

The barrel arbor has at its upper end the ordinary square, and on this square is adjusted a large wheel, as large, indeed, as the size of the watch allows of, or, which is the same,

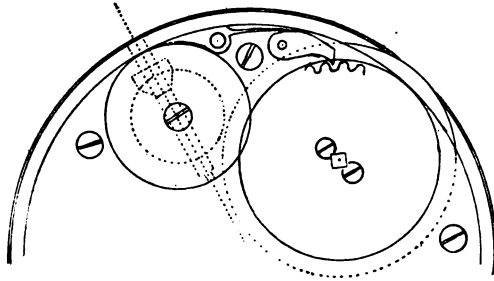

FIG. 37

nearly the size of the barrel. This wheel is in gear with another wheel of about two-thirds its size, which is concentrically connected with a conical wheel below the upper plate. This latter wheel is set in motion by a bevel pinion, the arbor of which extends through the pendant of the watch and has a rified button at its end outside of the pendant. One of the two flat wheels on top of the upper plate has at the same time to perform the service of a ratchet, by means of a properly shaped click and spring. This is the fundamental principle of the oldest stem-winding watches, but many improvements have been made on it.

132. For the purpose of setting hands, devices of various kinds may be connected with the previously mentioned parts. The oldest plan of this kind was the following: The winding pinion had a lengthwise motion, and upon pulling the

knob out a little, the toothed part of the pinion came out of gear with the bevel or crown wheel, and by means of a lever a small crown wheel was pushed in gear with the minute wheel or another wheel connected with it. The small crown wheel was adjusted with a pipe into the inner part of the axis of the winding pinion, either on a square or on the round

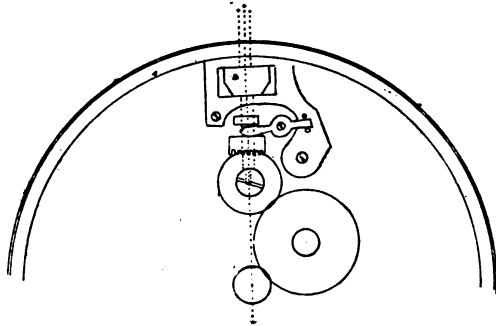

FIG. 32.

axis, having one side flattened about one-fourth of its thickness. The pipe of the wheel, in this case, had a steel pin screwed into its side so as to project a little in the hole, thereby getting sufficient hold on the flattened side of the axis to prevent the wheel from revolving on it, only allowing it a sliding movement in the direction of the pinion axis. (Fig. 32 shows the situation of the parts with the knob pulled out).

133. Another plan was as follows: There was a small pinion adjusted to the inner round end of the winding pinion arbor, and freely turned on it. The minute wheel geared into a similar wheel, having another row of contrite or crown teeth, and these teeth were constantly in gear with the little pinion on the winding arbor, so that these two parts were following the movement of the motion work when the watch was going. This little pinion was kept in its position by a bridge, and had a small pipe projecting towards the end of the winding axis, and this pipe had two rectangular cuts across its face, forming thus four recesses, broad and deep enough to receive a pin fastened in a hole drilled across the extremity of the arbor. Thus, by pulling the knob and winding pinion out, the pin,

when entered into one of the cross cuts, made the pinion follow its motion, and thus imparted the movement to the motion work. By pushing the knob back to its former position, the motion work became disconnected, and the winding action was in gear as before.

134. This way of setting hands, certainly very simple and reliable, was found objectionable, because the knob, when pulled out for setting hands, was often left in that position by careless wearers, and the watch, having then to move also the winding pinion with its considerable friction, was quite unable to perform the increased task, and stopped altogether. This was a drawback which has essentially produced mistrust against keyless watches, and finally it has led to dropping the device of pulling out the knob for setting hands.

135. Another plan has found much favor, and may be said to answer the purpose very nearly. The winding parts are exactly the same as described, with the only difference that the

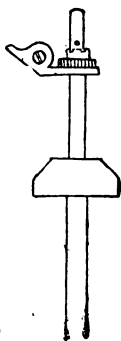

FIG. 33.

winding pinion is fitted loosely on a round axis, the inner end of which, as far as it projects from the winding pinion, is square. On this square a little steel tube, with a square hole, is adjusted, loose enough to move with ease up and down the square. The face of the winding pinion and the corresponding face of this tube are cut with ratchet teeth, forming exact counterparts of each other. A gearing, acting in a notch round the periphery of the tube, keeps the two parts constantly connected with each other, so that the winding pinion participates in the motion of the winding axis.

136. When the setting of the hands is required, a small button or push piece projecting from the case near the stem, is pushed in and causes the spring to slide the tube downward on the square. The other face of the tube has a small set of con-trite teeth which, by this movement, come into gear with the minute wheel itself, or another small wheel connected with the same. At the same time the ratchet teeth of the tube are drawn out of action with those of the winding

pinion, so that the latter does not follow the movement of the axis, and when the setting has been done, the button, released from the pressure, allows the spring to bring the tube back to its former position ready for winding.

137. There is a secondary advantage in this arrangement, inasmuch as it prevents any damage to the winding parts and click-work in case of any one turning the winding knob the wrong way, because, in this case, the two ratchets produce the effect of a so-called kregnet-key.

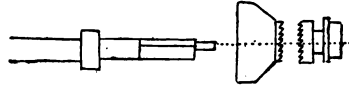

FIG. 34.

138. Nevertheless, objections have been raised also against this system, because the side opening in the rim of the case for

the passage of the button was thought a means of letting dust, etc., penetrate into the movement, and because the projecting button may, under unfavorable circumstances, be forced in while the watch is in the pocket.

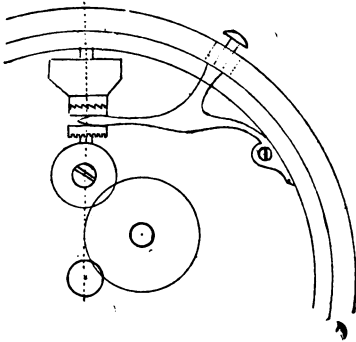

FIG. 35.

For these reasons, much skill and sagacity was spent on other methods of setting the hands in motion.

139. One of them consists of a rather complicated arrangement of the bow of the case, establishing the connection with the motion work when the bow is put down. The advantages to be expected by this contrivance are very doubtful, since the bow may be accidentally put down in wearing the watch, thus bringing it to a stand-still. Besides, many people have the commendable custom of always putting the bow down when laying a watch flat on a table, in order to prevent the polish or engine turning being scratched. This, of course, would lead to the same result.

140. Other contrivances have been made with keyless hunters, to the effect of having the push piece protected by the front cover of the case, and projecting from the periphery of the bezel. This push-piece, when pushed inward, causes a part of its spring to get hold at the outer edge of the bezel, and from this moment the winding ceases, and the motion work is and remains in connection with the winding axis. This hold of the spring and push-piece is released by shutting the case, and every part is in its former situation. This plan answers excellently for every purpose, but if the hands are set without shutting the case afterwards, which some people do when coming home or going to bed, it will evidently stop.

THE KEYLESS MECHANISM.

141. From the foregoing observations some conclusions for the setting hands mechanism may be arrived at, and I always thought these parts ought to be constructed in such a way that:

1st. The motion work can never come into contact with them by any accidental cause; on the contrary, they should be so arranged as to require a decided act of the wearer to establish their effect on the motion work.

2d. After having set the hands, the said mechanism ought to go out of gear with the minute wheel by its own action, and without requiring any care whatever of the wearer.

These two principles are of the utmost importance for the good and reliable service of the watch, for a watch invariably stops if the keyless mechanism comes into, or remains in gear with the motion work at a wrong time; and a construction which requires a degree of care which not all wearers bestow on their watches, must be called defective, so long as other constructions may be attained without this weak point.

142. That kind of keyless mechanism with which the hands are set by laying down the bow of the case, implies a neglect of both the above principles. Those mechanisms which require the knob being pulled out, and those in which the push-piece keeps hold till the case is closed, are against the second of those principles.

143. There is an arrangement which is entirely free from the above mentioned objections (138), and applicable to open faced and hunting cases, in which the push-piece projects from under the bezel, and flat with the outside of the case. Its thickness of about one millim., or a trifle more, allows of its being pushed in with the nail without difficulty. The rim of the bezel in the open face case, or that of the front cover of a hunting case, must be filed through so that the end of the push-piece just fits into it.

It is evident that there is no opening for the entrance of dust, that no pressure from outside can move the push-piece, and the former free position of the setting hands mechanism is instantly re-established by the action of the push-piece spring as soon as the setting has been done. The only inconvenience resulting from this arrangement is, that an open faced watch of this kind requires the glass bezel to be opened for setting the hands, which is not necessary with the projecting push-piece. But with a well regulated watch the setting hands is a rare occurrence, and even a little inconvenience in these cases is of no great consequence.

144. The other principal group of keyless mechanisms, those with the rocking platform, will also require some study. They offer some very important advantages, especially for fusee watches, where the fusee arbor, not being stationary, like the barrel arbor of a going barrel watch, requires an absolute independence of the rest of the keyless mechanisms at any time, except in the moment of winding. Therefore, the wheels on the rocking bar or platform, in a fusee movement, must be kept by a spring in a neutral position, touching neither fusee wheel nor motion wheel.

145. Most of these keyless mechanisms have three wheels on the rocking bar, the middle one being the bevel wheel into which the winding pinion gears. This latter requires no prolongation of its axis into the movement, and in many watches it depends only on the bearing of its arbor in the pendant of the case for its support. This, however, is objectionable, and the considerable amount of side pressure which always results from any angular transmission, strongly indicates the necessity

of giving the inner end of the pinion a support on the edge of the pillar plate, which is so easy to obtain. A pinion supported in this way allows also of inspecting the bevel gear without having the movement in the case, a convenience of some value. The rocking bar is fastened in such a way that the center of its oscillatory movement is the center of the bevel wheel, so that the two wheels gearing into it at both sides remain in regular action with it in whatever position the bar may be. One of these wheels is continually in gear with the barrel wheel on the square of the barrel arbor, to which it communicates the winding action. The other wheel stands sufficiently apart from the teeth of the minute wheel of the motion work, so that it does not touch the teeth of it when the wheel at the other side of the bar is clear out of gear with the barrel wheel. Moreover, it is held at a sufficient distance from the minute wheel by a spring acting on the working bar. (Fig. 36.)

146. Setting the hands requires the inverse position of the rocking bar to be established by external pressure on a push-piece, to which the same observations apply as made on this subject before (138-143). The push-piece produces a change of position of the bar, bringing the other wheel on it into gear with the minute wheel, while a banking pin prevents the movement being extended farther than required for a safe depth. After setting the hands, the bar is brought to its former position by its spring.

147. This arrangement has also the so-called Breguet click, and if it is attempted to wind the wrong way, the clickwork prevents the barrel wheel from following the motion in this direction, and the rounded parts of the teeth of the rocking wheel slide over those of the barrel wheel, so that no harm can be done to any part of the mechanism.

148. In fusee movements, as already explained, this mechanism requires another arrangement, inasmuch as the wheels of the rocking bar must be kept in a middle position between the winding and setting action, which is produced by a properly applied spring. For bringing the rocking bar to act on the fusee wheel, no push-piece is required. Here we see one

of the surprising effects of friction, which is a constant and obstinate adversary of the watchmaker. The friction of the small intermediate wheel on its stud on the bar causes this latter to move around the center of the bevel wheel by the reaction of the gear, as soon as the winding pinion is turned in the right direction. If this friction by itself is not sufficient to throw the wheel into gear with the fusee wheel with the necessary security, a small stiffening spring must be applied underneath the intermediate wheel, in a recess at the lower side of it. For setting hands the usual push-piece must be resorted to. When turning the knob the wrong way, the fusee watch, having no Breguet action, the wheels on the rocking bar only move freely and without any effect whatever.

149. A beautifully devised keyless mechanism, with rocking platform, is that of Mr. V. Kullberg, one of the first rate London makers. This mechanism has but two wheels, and the motion of the bar is derived from very subtile effects of frictional reaction of the gearing wheels. The only drawback to it is the necessity of a straight toothed pinion and contrate wheel, since the bar does not oscillate round the center of the contrate wheel.

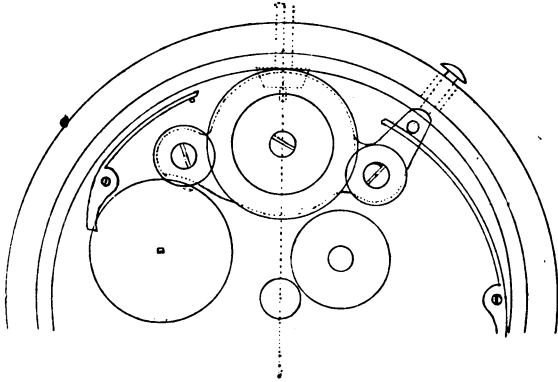

FIG. 36.

150. After the foregoing observations on the nature of these two principal classes of keyless mechanism, and their essential functions, it remains to say some words about the way in which they are applied to the movement.

The movement delineated in Fig. 37 admits, for hunting watches, the application of the keyless mechanism without the slightest change in its disposition, except setting the pillars a little farther towards the edge of the plate, in order to have the pillar screws free of the large winding wheels. The lower pivot of the three-wheel pinion, also, will have to be set in the pillar plate instead of the bar, because the room at this place will be required for the minute wheel.

If the winding wheels are to be level with the upper plate, this latter must be left so much thicker; a very commendable plan, because it utilizes the additional height required for the winding wheels to give greater length to the axis of the train (60). In any other respect the disposition of the movement and all its parts, is the same, whether it is a keyless or key-winding one.

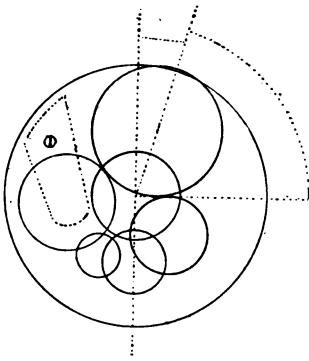

FIG. 37.

151. The arrangement of the keyless mechanism in an open-faced watch, on the contrary, is rather difficult, if the winding operation is to be performed at the pendant, which is the most convenient of all the places that might be assigned to it. The pendant of an open-faced watch always corresponds to the XII. of the dial, and if the watch is to have a seconds hand on an eccentric seconds dial, which is

the general rule for the watches of our period, the position of the barrel with respect to the pendant can only be altered within very narrow limits, if essential deviations from the principles of constructing the train (53) are to be avoided. In a well constructed movement (Fig. 37) the angular distance between the pendant line and the barrel center, taking the center movement to be the summit of the angle, is about 20° ; while in the same movement, when put in a hunting case, the pendant of which is at the III. of the dial, this angle is $90 - 20 = 70^\circ$, a very convenient distance for the placement

of the keyless mechanism, while 20° are wholly insufficient for the purpose.

152. For avoiding this difficulty, several methods have been adopted, and there was hardly any proceeding showing more forcibly the necessity under which the constructor of a watch constantly finds himself, to subordinate his better knowledge to the taste and to the habits of the public. Making the keyless open-faced watches without seconds would do away altogether with the difficulty, since the place of the barrel may then be chosen quite freely; but the public want all watches with seconds.

It has been tried for a considerable period to arrange the dial in another way, so as to have the seconds dial at another place, say at the VIII. or IX. of the dial, but the taste of the public refused the offer, though irreproachable from the constructional point of view. Symmetry of the dial was pronounced an imperative necessity.

In this awkward position it may be called a very ingenious expedient that some manufacturers tried to establish the sacrificed symmetry of dial by adding a date hand to it, symmetrically situated with the seconds hand; but the additional cost of this dial, for which no essential want was existing, was again an objection.

Others, again, provided the train with an auxiliary fourth pinion, serving merely to carry the seconds hand. This system realizes a sufficient distance between pendant and barrel for the placement of the keyless mechanism, with the seconds dial at its ordinary place; but it must be objected to so much the more, as it not only burdens the train with moving an additional axis, but also with the friction which must be applied to this pinion by a small spring in order to prevent the shake of the tothing being indicated by the seconds hand.

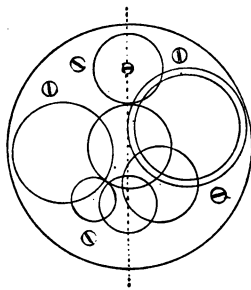

FIG. 38.

153. It is possible to increase the above mentioned angle by adopting essentially smaller train wheels. In the generally

adopted type of the Swiss manufactures this angular distance is often increased up to 30° and even 35° , on account of the wheels being much smaller than they might have been with respect to the room afforded by the dimensions of the frame. A further increase might be obtainable by approaching the third wheel to the barrel so as to have it go under the toothed rim of the latter, at the proper distance for leaving it just free from the cylindrical part of the barrel. But with all these various efforts, and the constructive defects involved in them it is not possible to establish sufficient room for the keyless parts.

154. For attaining this purpose, a step of greater boldness was necessary, which, notwithstanding its infringements against the principles of sound and correct construction, has been sanctioned by the trade and public, in the absence of a better expedient.

It consists in placing the third wheel pinion with its arbor quite close to the periphery of the barrel, and the necessary space for the wheel must be granted above the centre wheel. The drawbacks of this arrangement are evident. The additional height of frame required by the superposition of the wheels, and the close disposition of three large moving parts, one over the other, are certainly very grave objections; but a watch is, more than many other articles, dependent upon the reigning taste, to the tyranny of which its construction must be subjected, and this must account for the fact that almost all open-faced keyless movements are disposed in this way. (Fig. 39.)

It must be said in favor of this method, that all the parts of the keyless mechanism are the same, and may be indifferently used for open-faced and hunting watches, and that all the parts of the train may be executed of the same regular dimensions as in a key-winding watch of the same size.

CHAPTER XII.

IF there be any way of overcoming the inconveniences in the construction of keyless open-faced watches, it must be found in the employment of another system of transmitting the winding power. As long as flat, bevel, and contrate wheels are exclusively employed, the difficulty can only be eluded by a construction just as vicious as the before-mentioned ones. A combination of an endless screw and one or two angular gears seems to afford a greater liberty of disposition; but I have not seen, as yet, a commendable construction of this kind. It seems the idea has not yet been sufficiently eliminated.

The source of difficulty lies evidently in the following circumstances:

If the winding operation is to be performed with a certain moderate number of revolutions of the winding knob (159), a very small wheel on the barrel arbor must be selected for receiving the action of the screw; but then the place for this latter must be granted above or under the barrel, and this necessarily increases the height of the movement. If, on the contrary, the wheel on the barrel arbor is large enough to admit the screw gear beyond the circumference of the barrel, the winding should be so excessively slow as to necessitate a transmission of power by a multiplicative train.

156. Lately I have succeeded in combining an open-faced keyless movement with greater ease in the arrangement of the train, by having a rocking platform under the dial. The pendant and barrel are at an angle of 45° , taken from the center, and the sizes of the train wheels are quite normal. The third wheel is fastened to a collet on the lower end of the pinion arbor, and moves in the space between the barrel-head and the lower bridge. This space is quite sufficient for

having the barrel and the third wheel amply clear each other, and on the other side of the barrel the center-wheel is placed quite in the usual way. A movement on this plan is hardly any higher than a key-winder of the same breadth of main-spring.

158. It remains now to speak of some other designs for winding, in which the force is not applied by the pendant. There were some old watches with a kind of keyless action by turning the dome of the watch case. This, however, has found no followers, in consequence of the impossibility of a dust-proof adjustment of the case, and because there were no means of setting the hands except in the usual way by using a key.

Other inventions had a circular rack, operated on by a slide projecting from the outside of the case, then winding by an intermittent or reciprocating motion.

Others, again, utilized the up and down motion of the front cover of a hunting case for winding up a small part of the spring, on the supposition that a hunting watch will undoubtedly be opened a certain number of times during the day, and thus be kept going. It is not difficult to estimate the value of an arrangement based upon such suppositions for its efficiency. It is the next thing to those old self-winding watches which were wound through the motion imparted to them by the walking of the wearer, and which required a good long walk every day for being kept going; or, instead of this, a good while of shaking up and down.

159. When constructing a keyless mechanism, it is very desirable to establish a certain relation between the turns of the winding knob and those produced at the barrel arbor. In the greatest part of carefully made keyless watches each revolution of the winding pinion operates one-third of a turn of the barrel arbor, or nearly so. This is a proportion which ought not to be much deviated from, in whatever direction, for if a greater speed is given to the winding, the operation is too hard to perform, especially for tender fingers. If, on the contrary, the winding effect is distributed over too great a number of turns, the action will be very easy, but at the same time a greater power



is put into the hands of the person winding, and this power may prove fatal to the acting parts, if not used with the appropriate discernment. Especially the end of the winding operation, in such cases, is attended with dangers for the stop-work, the teeth of the barrel and center-pinion, etc. With the rocking bar mechanisms, the relation of turns is simply in the relation of the numbers of the winding pinion and the barrel wheel.

But the other group of keyless works having a multiplication of speed by the flat wheel moving on the axis of the contrate wheel, the ratio between the numbers of these two must be taken into calculation. If, for example, the winding pinion has 12 teeth, the contrate wheel 24, the flat wheel on it 40, the barrel wheel 60 teeth, the result will be:

$$\frac{12 \times 40}{24 \times 60} = \frac{1}{3}$$

that is, one revolution of the pinion operates one-third revolution of the barrel arbor.

160. There is another danger resulting from violent winding in those watches which have a large winding wheel with fine teeth, or the click-work acting in the teeth of this wheel. The immoderate winding effort, suddenly cut off by the action of the stop-work, and generally at the opposite end of the barrel arbor, produces a small degree of torsion of this latter, and one more tooth of the wheel is forced to pass the click. From this moment the watch acts under the influence of the full power of the mainspring, increased by the reaction of this torsion transmitted by the stop-work, and begins to bank violently, and often continues so for some minutes. This is always accompanied with no small danger for the acting parts of the escapement, and in case of no lasting injury to the watch, it produces a considerable deviation of rate.

Many a good keyless watch, when carefully treated, with an irreproachable rate, has been discredited by irregular performance, resulting from rough treatment in winding.

161. A very simple remedy against this inconvenience consists in giving the click a small amount of shake on its screw or stud. The recoil resulting from this shake is sufficient to ease any torsional strain of the kind above described.

I have also made keyless watches with an extra ratchet underneath the large winding wheel on the barrel arbor, and found them to answer quite well. The ratchet was taken off the size of that in a key-winding watch, and, with rather vigorous teeth, it has sufficient recoil to make up for any torsion. The room for this ratchet is abundant, and the tail of the click, if made rather long, allows for letting down the spring without taking off the barrel wheel. A click-work of this kind never causes any trouble in casing, while those click-works which are laid in the level of the winding wheels, and at the edge of the larger ones of them, sometimes are troublesome to get clear from the dome of the case.

162. The movement of a keyless watch ought not to be charged with any extra friction of moving parts, if it can be avoided. In some watches of this kind the motion work has to carry with it one or two setting wheels, and sometimes a pinion, all of them adjusted in a way which does not reduce friction to its least amount. As soon as one of these stop-screws has been overlooked, when the repairer provides the movement with oil, the friction created by it will bring the watch to a stand-still, especially when the sink for the screw's head fits rather closely. All these accessories ought to be brought into action only in the moment of setting the hands, and should recede and leave the motion work entirely free. Care must be taken that the setting wheel acts in the direction of the center of the minute wheel when pushed into gear. The teeth of this wheel, too, ought to be pointed and thin, so that its entering into gear causes no sudden displacement of the hands if the teeth of both wheels chance to meet with their points.

163. The form of the teeth of the winding wheels and pinions, as usually made, may be classified into two kinds. The one is the usual form of wheel teeth, and the other one, much in favor with Swiss makers, has a ratchet-like tooth, both for the flat and angular gear. This latter form, if properly made, is by no means objectionable, since these wheels always act in but one direction, so that the shape of that side of the tooth not called into action is of no consequence, and

the only consideration for it must be to give it the greatest possible degree of strength. The very thin wheels generally used in Swiss keyless watches fully justified this way of shaping the teeth; but then the natural character of the tooth ought to be an epicycloid on the acting side, with a hollow back just affording the necessary room for the tooth of the other wheel to pass freely. Most wheels of this kind, however, have so strangely shaped teeth that they make the impression as though taste had a principal share in their construction.

Winding wheels of proportionate thickness may, without fear of breakage, have the common shape of tooth. Certainly teeth ought not to be too fine, and the flanks and bottom must offer the best conditions of strength. Therefore they must be short, and may be so, since they have only to lead through a very small angle, after which they are relieved in the gear by the next tooth. The sides ought to diverge slightly, thus giving an increase of breadth to the lower part of the tooth, and the bottom ought to be hollow.

164. The size of the teeth is, with the keyless mechanisms of the rocking bar category, essentially prescribed by the toothing of the motion work, and in consequence of it, most of these mechanisms have finer-toothed wheels than desirable. A little extra wheel, concentrically adjusted upon the setting wheel, and of the same size teeth with the minute wheel, will relieve from all restriction and enable the constructor to use teeth of the proper size. With the mechanisms of the other class, the size of teeth is quite optional.

165. As a material for the winding parts, steel is generally used; and for the pinions no other known metal would prove suitable. With respect to the wheels, and especially the large ones, I always thought steel, when hardened, might not be sufficiently reliable, since nobody can know whether there is not a tendency to break in some part of it. For these reasons I made them of aluminium bronze for a time, but I had to give it up, not that they had given any reason of complaint, but only because customers seemed to prefer the look of steel wheels.

166. The casing of keyless movements requires some extra work as compared with that of key-winders. The fixing pin, contrary to the general rule (90), must here be near the pendant, because, if not, the movement could not be put in. In the keyless watches with the setting parts on the winding axis, I find it a good plan to have this axis removable, and have it secured by a bridge fixed at the edge of the pillar plate. The inner pivot of the axis moves, as usual, in a brass stud riveted into the pillar plate.

The pinion and the setting cannon must have just the necessary freedom in the sinks made for them in the pillar plate, so that they remain in their places when the axis is drawn out, lest they should make the reinsertion of the axis rather difficult.

This arrangement greatly facilitates the casing, and has also the additional advantage that the action of the winding pinion and contrate wheel can be verified without the movement being in the case.

The winding knob is fixed to the outer extremity of the axis in the common way, and the axis is held in its place by a screw going through one half of the pendant, the inner end projecting into a notch turned into the axis. The head of the screw is sunk into the outside of the pendant.

With this disposition, a movement, after taking out the axis, can be taken out of the case and put into it with the same ease as a simple movement. For hunting watches a little allowance must be made for a small motion of the axis in the direction of its length, for the purpose of opening the front cover of the case. For effecting this the shutting spring has a hole through which the axis passes freely, while a shoulder of the same pushes the spring inward by a pressure on the knob.

167. The push-piece in many keyless watches projects from the periphery of the rim of the case. If such is the case, it ought to be adjusted in a way as to completely shut the opening in the case. A round pin with a head outside generally answers very well, and so does also a round disc of about half the thickness of the rim, and projecting a little less than half its surface. (Fig. 36).

These projecting push-pieces, however, have been much objected to from several points of view. The first and most serious objection was, that any accidental pressure might push the motion work into gear, and thus alter the position of the hands or arresting their course. With the large-linked heavy chains worn now, it is not a rare occurrence that a part of the chain gets into the pocket, and by some chance presses against the push-piece. Another objection is, the apprehension that dust may find its way through the opening for the push-piece. This is, however, of no great consequence, for a push-piece fitted in a careful and judicious way will not allow much dust to penetrate in. The projecting push-pieces have also been objected to on the ground of good taste, which will not suffer any unsymmetrical protuberance. This argument is not of great weight.

168. The combined influence of these circumstances has created a desire to invent some means for setting the hands without any external push-piece, or, when keeping this latter, at least avoiding its principal defect—the liability of being pressed inwardly by casualties not under the control of the wearer.

The former category of devices have already been described and treated (136–143). In the latter direction, the purpose is very well attained by some contrivances of recent date.

Some have the external push-piece of the common kind; a small pin fastened into the push-piece, vertical to the direction of its movement, which projects from the rim of the case and reaches into a corresponding notch or hole of the rim of the front cover (hunting case). This prevents any displacement as long as the case is shut. If the front cover is open, the setting wheel can be pushed in and comes out afterwards by self-action, and is again secured by shutting the front cover.

Other watches have a round push-piece with a head, and this latter is prevented from being pushed in by a part of the rim of the front cover which it overlaps slightly. This obstacle is removed with the opening of the front cover as with the before-mentioned one.

Another contrivance of a similar kind is the following: A pipe is soldered into the rim of the case so that it projects a little outside, and the push-piece is a piece of round wire fitting into it, with its outer end flush with the end of the pipe. A slit is cut across the pipe just the width to allow the nail of the thumb to penetrate into it and push the piece inward, which, by any other touch, could not be done.

169. The form of the winding knob is subject to many influences of taste. The watches, the setting of which is done by pulling the knob out, must have such a form as to prevent any pulling out when winding. But for all the other keyless mechanisms a form of knob should be chosen which allows of applying the force on its greatest diameter. This not only utilizes the most favorable leverage, but also the place where the rifling of the knob is deepest—both circumstances facilitating the winding operation.

ll =
100

f:
a
g
A
of
d,

y
e
it
ss
rs
y
e
i-

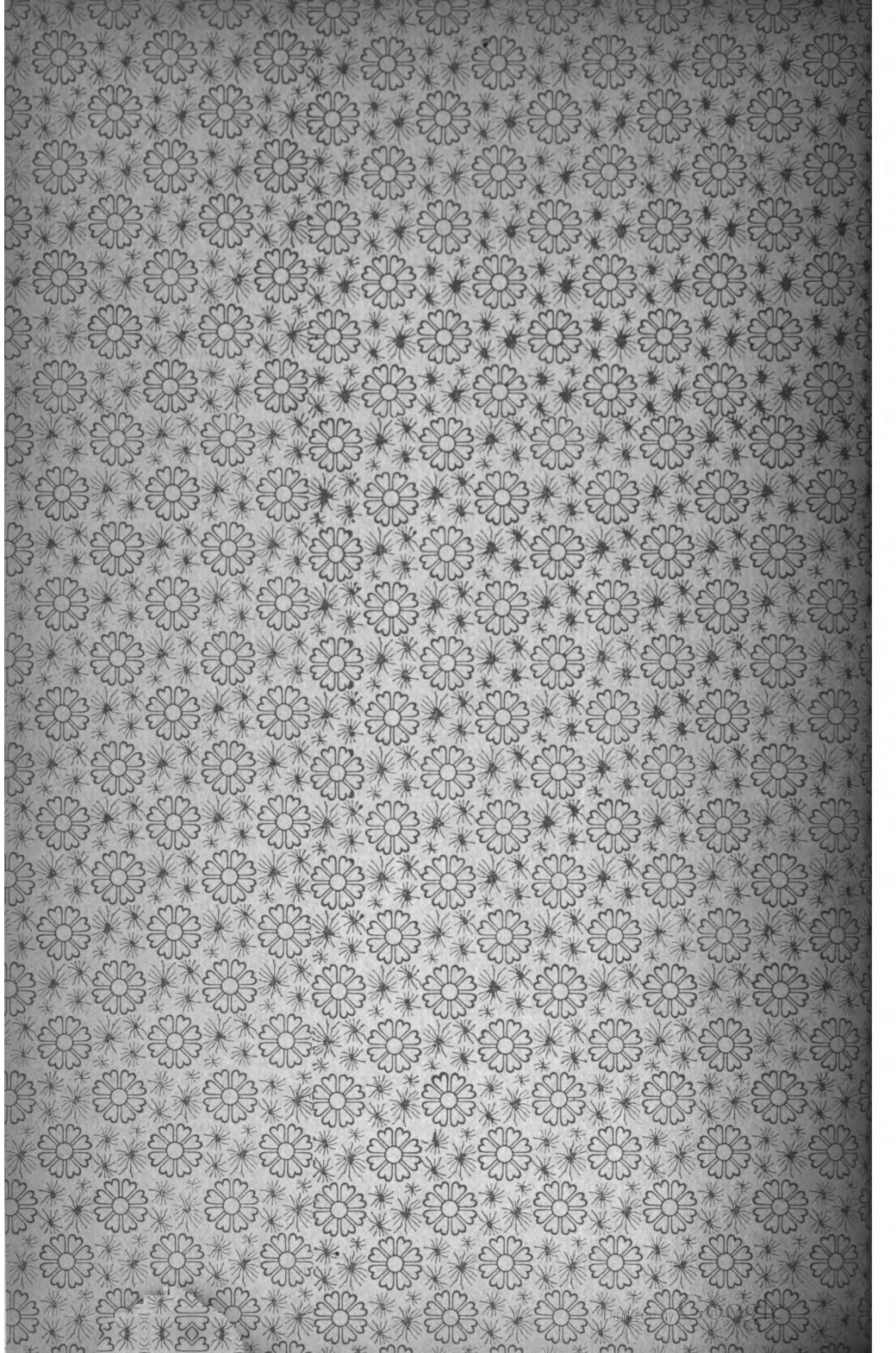

UNIVERSITY OF MICHIGAN



3 9015 06456 3243

